

November 2017



# Investment Plan for Lesotho



Department of Energy  
Ministry of Energy & Meteorology  
Government of Lesotho





Telephone: (+266) 22311100

Fax: (+266) 22310281

In reply please quote:

Your Reference:



LESOTHO

Ministry of Development Planning

P.O. Box 630

Maseru 100

Lesotho

MDP/MDP/6

26<sup>th</sup> October, 2017

Ms Mafalda Duarte  
Program Manager  
Climate Investment Funds  
CIF Administrative Unit  
1818 H Street NW  
Washington, DC 20433  
United States of America

Dear Ms Duarte,

**RE: SREP INVESTMENT PLAN OF THE GOVERNMENT OF LESOTHO**

It is with great honour that I submit this Investment Plan (IP) for Scaling-up Renewable Energy (RE) in the Kingdom of Lesotho to the Climate Investment Fund (CIF) SREP Sub-Committee for consideration. The Government of Lesotho greatly appreciates the financial support provided by CIF and technical support from the Multilateral Development Banks in particular, the World Bank and African Development Bank, to develop this SREP IP for the Kingdom of Lesotho. It is our hope that the SREP Sub-Committee will endorse the IP to give Lesotho an opportunity to scale-up the use of RE sources to reduce the cost of energy and increase access to cleaner and modern sources of energy in the country.

The Government of Lesotho is committed to pursuing sustainable economic development in line with its Vision 2020. Energy is a key driver that is integral for economic growth, social development and for improvement in the livelihood of communities, especially those in the rural areas who do not have access to clean and modern sources of energy. Lesotho has its own challenges and opportunities in terms of its energy situation. Our extremely low national electricity coverage, high energy costs and high dependence on imported fossil fuel is exacerbated by the mountainous terrain that limits network expansion.

Although our country is blessed with abundant RE resources, investment in renewable energies is yet to materialize on a large-scale. The Government recognizes that private sector investment can be the driving force that enables our country to exploit the full potential of these resources. This IP being presented to the SREP Sub-Committee will go a long way in assisting the Government to achieve this vision.

Throughout the development of this IP there has been extensive consultation with all the relevant government ministries, private sector organisations, development partners and civil societies to ensure buy-in from all key stakeholders.

The IP identifies the renewable energy technologies and projects that will contribute positively to the sustainable economic development of the Kingdom of Lesotho. The plan outlines activities that must be carried out to realize the projects and also identifies financing modalities under which SREP can help to leverage concessional and private sector financing.

The IP finds that SREP support can be instrumental in helping to catalyse investment in three (3) components recommended to increase RE development: on-grid RE technologies; off-grid RE systems; and Small Hydro Power Projects technical assistance.

The Government of Lesotho is grateful for the opportunity to share with you our vision for how SREP support can enable a scale-up in RE investment and looks forward to working with CIF, Multi Developments Banks and development partners to successfully implement the programmes and activities within each component of the plan.

**Yours Sincerely**



**Hon. Tlohelang Aumane (Mr)**

**Minister**

**Ministry of Development Planning**

# Table of Contents

<b>1</b>	<b>Investment Plan Summary</b>	<b>1</b>
1.1	Brief Country and Energy Sector Context	1
1.2	Challenges in the Energy Sector	1
1.3	Renewable Energy in Lesotho	3
1.4	Proposed Investment Program for Lesotho	4
<b>2</b>	<b>Country Context</b>	<b>7</b>
<b>3</b>	<b>Overview of the Energy Sector</b>	<b>13</b>
3.1	Institutional, Legal, and Regulatory Framework	15
3.2	Electricity Supply	18
3.3	Electricity Demand	22
3.4	Key Challenges in the Energy Sector	24
<b>4</b>	<b>Overview of the Renewable Energy Sector</b>	<b>26</b>
4.1	Potential for On-Grid Renewable Energy Technologies	27
4.2	Potential for Off-Grid Renewable Energy Technologies	37
4.3	Availability of Financing for Renewable Energy Projects and Technologies in Lesotho	46
4.4	Key Barriers to Scaling-Up Renewable Energy and Proposed Mitigation Measures	51
<b>5</b>	<b>Financial and Economic Viability of Renewable Energy Technologies</b>	<b>55</b>
5.1	RE Technology Costs	55
5.2	Economic Viability Analysis	56
5.3	Financial Viability Analysis	59
5.4	Cost of Other Distributed RE Technologies	62
<b>6</b>	<b>Prioritization of Renewable Energy Technologies</b>	<b>64</b>
<b>7</b>	<b>Program Description</b>	<b>72</b>
7.1	Component 1: On-Grid RE Technologies	73
7.2	Component 2: Distributed RE Solutions	75
7.3	Environmental and Social Co-Benefits	78
7.4	Environmental and Social Risks	79
<b>8</b>	<b>Financing Plan and Instruments</b>	<b>81</b>
<b>9</b>	<b>Responsiveness to SREP Criteria</b>	<b>83</b>
<b>10</b>	<b>Implementation Potential with Risk Assessment</b>	<b>89</b>

<b>11</b>	<b>Monitoring and Evaluation</b>	<b>91</b>
-----------	----------------------------------	-----------

## **Appendices**

<b>Appendix A : Project Concept Briefs</b>	<b>93</b>
<b>Appendix B : Assessment of Lesotho’s Absorptive Capacity</b>	<b>102</b>
<b>Appendix C : Stakeholder Consultations</b>	<b>105</b>
<b>Appendix D : Co-Benefits</b>	<b>111</b>
<b>Appendix E : Comments from the Independent Technical Reviewer</b>	<b>113</b>
<b>Appendix F : Overview of the Concept of LCOE</b>	<b>118</b>
<b>Appendix G : Preparation Grant and MDB Payment Requests</b>	<b>119</b>

## **Appendix Tables**

<b>Appendix Table A.1: Proposed Financing Plan for Distributed RE Solutions</b>	<b>101</b>
<b>Appendix Table A.2: Proposed Schedule</b>	<b>101</b>
<b>Appendix Table B.1: GDP Growth and Projected GDP Growth in Lesotho, 2010-2020</b>	<b>102</b>
<b>Appendix Table B.2: Lesotho’s Debt-to-GDP Ratio and IMF Projections, 2012-2020</b>	<b>103</b>
<b>Appendix Table C.1: Stakeholders met during the Scoping Mission</b>	<b>105</b>
<b>Appendix Table C.2: Stakeholders met During the Joint Mission</b>	<b>108</b>
<b>Appendix Table D.1: Co-Benefits Associated with SREP Impacts and Outcomes</b>	<b>111</b>
<b>Appendix Table E.1: SREP Project Preparation Grant Request (On-Grid RE Technologies)</b>	<b>113</b>
<b>Appendix Table G.1: SREP Project Preparation Grant Request (On-Grid RE Technologies)</b>	<b>119</b>
<b>Appendix Table G.2: MDB Request for Payment for Project Implementation Services</b>	<b>121</b>
<b>Appendix Table G.3: SREP Project Preparation Grant Request (Distributed RE solutions)</b>	<b>122</b>
<b>Appendix Table G.4: MDB Request for Payment for Project Implementation Services</b>	<b>124</b>

## Tables

<b>Table 1.1: Summary of RE Technical Potential</b>	<b>4</b>
<b>Table 1.2: Lesotho SREP IP Financing Plan</b>	<b>6</b>
<b>Table 2.1: Effects and Impact of Climate Change in Lesotho</b>	<b>11</b>
<b>Table 3.1: Key Sector Legislation</b>	<b>17</b>
<b>Table 3.2: Key Regulations and Guidelines</b>	<b>18</b>
<b>Table 3.3: Generation Assets in Lesotho</b>	<b>19</b>
<b>Table 4.1: Summary of RE Technical Potential</b>	<b>26</b>
<b>Table 4.2: Existing and Proposed Utility-Scale Solar PV Projects</b>	<b>28</b>
<b>Table 4.3: Solar Parks Technical Potential by District, Case 2</b>	<b>29</b>
<b>Table 4.4: Technical Potential of Proposed Solar Park Projects</b>	<b>30</b>
<b>Table 4.5: Planned and Proposed Utility-Scale Wind Power Projects</b>	<b>30</b>
<b>Table 4.6: Buildable Capacity of Wind Farms by Capacity Factor</b>	<b>32</b>
<b>Table 4.7: Potential Wind Farm Projects</b>	<b>32</b>
<b>Table 4.8: Potential Small Hydropower Plant Sites Proposed in the Hydrogeneration Master Plan</b>	<b>33</b>
<b>Table 4.9: Summary of Potential Small Hydropower Sites</b>	<b>35</b>
<b>Table 4.10: Summary of Waste Resource Potential in Four Districts</b>	<b>36</b>
<b>Table 4.11: Technical Potential for Microgrids</b>	<b>39</b>
<b>Table 4.12: Technical Potential of Proposed Floating Micro-Hydro Projects</b>	<b>40</b>
<b>Table 4.13: Technical Potential for SHS</b>	<b>42</b>
<b>Table 4.14: Existing Solar Water Heating Projects in Lesotho</b>	<b>44</b>
<b>Table 4.15: Summary of Key Private Sector and NGO Entities in RE</b>	<b>47</b>
<b>Table 4.16: Summary of Ongoing Development Partner Projects</b>	<b>49</b>
<b>Table 4.17: Summary of Barriers to RE and Potential Mitigation Measures</b>	<b>52</b>
<b>Table 5.1 Costs Assumptions for On-grid RE Technologies</b>	<b>55</b>
<b>Table 5.2 Costs Assumptions for Off-grid RE Technologies</b>	<b>56</b>
<b>Table 5.3: Financing Terms of Financial Viability Scenarios</b>	<b>59</b>
<b>Table 6.1: SREP Criteria for Technology Prioritisation</b>	<b>64</b>
<b>Table 6.2: Government Criteria for Technology Prioritization</b>	<b>66</b>
<b>Table 6.3: Evaluation of RE Technologies against SREP and GoL Criteria</b>	<b>67</b>
<b>Table 6.4: Prioritization Results</b>	<b>71</b>

<b>Table 8.1: Lesotho SREP IP Financing Plan</b>	<b>82</b>
<b>Table 9.1: Summary of Proposed Projects' Responsiveness to SREP Criteria</b>	<b>83</b>
<b>Table 10.1: Risk Assessment of the SREP Programme in Lesotho</b>	<b>89</b>
<b>Table 11.1: Lesotho SREP Investment Plan Results Framework</b>	<b>91</b>

## **Figures**

<b>Figure 2.1: Administrative Districts in Lesotho</b>	<b>7</b>
<b>Figure 2.2 Population Composition, 1990 – 2015</b>	<b>8</b>
<b>Figure 2.3: Structural Changes to the Economy of Lesotho, 1975 – 2015</b>	<b>8</b>
<b>Figure 2.4 Economic Growth in Lesotho and South Africa, 2005-2015</b>	<b>9</b>
<b>Figure 2.5: Poverty Headcount Ratio at US\$ 1.25 a Day in Sub-Saharan Africa</b>	<b>10</b>
<b>Figure 2.6: Poverty Rates and Sources of Income</b>	<b>10</b>
<b>Figure 3.1: Energy Demand and Supply</b>	<b>13</b>
<b>Figure 3.2: Final Energy Consumption by Sector and Source (TJ), 2010</b>	<b>14</b>
<b>Figure 3.3: Sources of Heating, Cooking, and Lighting for Households in Lesotho</b>	<b>14</b>
<b>Figure 3.4: LEC Purchases, 2012 - 2016</b>	<b>19</b>
<b>Figure 3.5: LEC Bulk Purchases by Intake Point, April 2015 to March 2016 (GWh)</b>	<b>20</b>
<b>Figure 3.6: Variable Tariff Path, 2007-2017</b>	<b>21</b>
<b>Figure 3.7: LEC's Cost of Service from 2010-2016</b>	<b>22</b>
<b>Figure 3.8: Yearly Electricity Sales by Customer Class, 2009-2015 (GWh)</b>	<b>23</b>
<b>Figure 3.9: Average Peak Electricity Demand, 2010-2016 (MW)</b>	<b>23</b>
<b>Figure 3.10: Load Forecast, 2016-2035 (MW)</b>	<b>24</b>
<b>Figure 4.1: Solar Park Resource Maps</b>	<b>29</b>
<b>Figure 4.2: Wind Resource Maps</b>	<b>31</b>
<b>Figure 4.3: Proposed Small Hydropower Plant Locations</b>	<b>34</b>
<b>Figure 4.4: Production Cycle for Proposed Waste-to-Energy Facilities</b>	<b>36</b>
<b>Figure 4.5: Floating Micro-Hydro Systems</b>	<b>40</b>
<b>Figure 4.6: Proposed Locations for Floating Micro-Hydro Projects</b>	<b>40</b>
<b>Figure 4.7: Progress in Rural Water Supply Solar Water Pump Retrofits, 2017</b>	<b>43</b>

<b>Figure 4.8: Solar Street Light, Lesotho Agricultural College</b>	<b>45</b>
<b>Figure 5.1: Economic Viability On-Grid RE</b>	<b>57</b>
<b>Figure 5.2: Economic Viability Off-Grid RE</b>	<b>59</b>
<b>Figure 5.3: Financial Viability (Commercial Financing) On-Grid</b>	<b>60</b>
<b>Figure 5.4: Financial Viability (Commercial Financing) Off-Grid</b>	<b>60</b>
<b>Figure 5.5: Financial Viability (Concessional Financing) On-Grid</b>	<b>62</b>
<b>Figure 5.6: Financial Viability (Concessional Financing) Off-Grid</b>	<b>62</b>



## Table of Abbreviations

ACE	African Clean Energy
ATS	Appropriate Technologies Services
CAPEX	Capital expenditure
DoE	Department of Energy
DFI	Development finance institution
EDM	Electricidade de Moçambique
ESCO	Energy Services Company
FEPA	Freshwater Ecological Protected Areas
FiT	Feed-in-Tariff
GDP	Gross domestic product
GHG	Greenhouse gas
GEF	Global Environment Facility
GoL	Government of Lesotho
HPP	Hydropower plant
IMF	International Monetary Fund
INDC	Intended Nationally Determined Contributions
ICS	Improved Cook Stove
IP	Investment plan
IPP	Independent power producer
IUCN	International Union for Conservation of Nature
LCOE	Levelized cost of energy
LEA	Lesotho Electricity Authority
LEC	Lesotho Electricity Company
LED	Light-emitting diode
LEWA	Lesotho Electricity and Water Authority
LHDA	Lesotho Highlands Development Authority
LHWP	Lesotho Highlands Water Project
LPG	Liquid Petroleum Gas
LREBRE	Lesotho Renewable Energy-Base Rural Electrification
M&E	Monitoring and evaluation
MDB	Multilateral Development Banks

MEM	Ministry of Energy and Meteorology
MHP	Muela Hydropower Plant
MW	Megawatt
NAPA	National Adaptation Programme of Action
NGO	Non-governmental organizations
NSDP	National Strategic Development Plan
PPA	Power purchase agreements
PRG	Partial risk guarantee
PV	Photovoltaic
PSP	Private sector participation
PPP	Public Private Partnership
RE	Renewable energy
REU	Rural Electrification Unit
SACU	Southern African Customs Union
SADC	Southern African Development Community
SHPP	Small hydropower plants
SHS	Solar home system
SREP	Scaling-Up Renewable Energy Program
SWHS	Solar water heating system
TA	Technical Assistance
UAF	Universal Access Fund
UNDP	United Nations Development Programme
UNEP	United Nations Environment Programme
UNSD	United Nations Statistics Division
WB	World Bank

# 1 Investment Plan Summary

## 1.1 Brief Country and Energy Sector Context

The Kingdom of Lesotho is a mountainous country in Southern Africa. Roughly 80 percent of Lesotho's land is more than 1,800 meters above sea level; the average elevation is 2,161 m.<sup>1</sup> Lesotho has a population of two million people of which more than 99 percent are ethnic Basotho.<sup>23</sup> Sixty-four percent of Basotho live in the districts of Berea, Leribe, Maseru, and Mafeteng, in the arable lowlands. The remaining population lives in six districts that include the Senqu River Valley and comparatively more mountainous land. Population growth has slowed since the early 1990s, from two percent a year to slightly more than one percent. Most people live in rural areas, but the share of the urban population has increased substantially, from 14 percent in 1990 to 27 percent in 2015.

Lesotho's economy has changed structurally; once based on remittance and agriculture, the country's economic growth is now driven by value-added output in the service sectors such as wholesale and retail trade and in manufacturing sectors such as textile manufacture and mining. Economic growth is steady, but has slowed down since 2011. As a result, unemployment and poverty levels are high. In 2015, the broad unemployment rate was 28 percent and 43 percent among the youth (ages 15 to 24).<sup>4</sup> The national poverty rate was 56 percent, among the highest in Africa.

Lesotho's energy sector is characterised by a reliance on biomass (wood and dung) and imported coal and petroleum. As of 2016, electricity, which makes up only 4 percent of Lesotho's energy balance is supplied to 38 percent of the population with generation from the Muela hydropower plant (72MW), and imports from Mozambique and South Africa. The rest of the population relies on multiple fuel sources to meet their energy needs. In rural areas, biomass is used for cooking and heating, and candles and paraffin for lighting. In urban areas, households rely less on biomass and more on paraffin and gas for heating and cooking. For lighting, urban households rely on a combination of electricity, paraffin and candles.

## 1.2 Challenges in the Energy Sector

The energy sector in Lesotho faces challenges which include: low access to modern and clean forms of energy, reliance on imported electricity and fuels (an energy security problem), and dwindling forest reserves. The Government of Lesotho recognizes that these challenges are a barrier to the country's development and has set targets to expand electricity access to 75 percent and increase the use of RE sources by 200MW by 2020.<sup>5</sup> The Government of Lesotho (GoL) is also committed to promoting the safe use of biofuels, reversing environmental degradation, and increasing the use of RE sources to increase energy security.

---

<sup>1</sup> GoL, "2016 Population and Housing Census Preliminary Results Report", 2017.

<sup>2</sup> "World Development Indicators," World Bank, accessed January 25, 2017.

<sup>3</sup> The term "Basotho" also refers to the demonym for Lesotho.

<sup>4</sup> The broad unemployment rate includes discouraged workers.

<sup>5</sup> GoL, "Vision 2020", 2000.

## **Lack of access to modern and clean forms of energy**

One of the primary challenges in Lesotho's energy sector is the low rate of household access to electricity and modern, cleaner sources of energy for lighting, heating, and cooking.<sup>6</sup> Access to affordable, modern energy sources reduces poverty, enables economic growth, improves health, and increases productivity.<sup>7</sup> Nationwide, only about 38 percent of households have access to electricity. Electricity access rates are 60 percent for urban and peri-urban households and 18 percent for rural households.<sup>8</sup>

Without electricity, households rely on paraffin and candles as sources of energy for lighting. For heating and cooking, majority of households use wood and dung. Burning these fuels in the home can lead to negative health outcomes. Gathering these fuels can also be time-consuming for households; according to African Clean Energy's 2015 survey of 2,652 rural households in Lesotho, households spent 31 hours per month travelling for fuel, covering an average distance of 58 km.<sup>9</sup>

## **Energy security**

Lesotho imports all its petroleum needs, some of its fuelwood needs, and 35 percent of its annual electricity needs (2016). At any given time, Lesotho has a maximum of 3 days of petroleum reserves. In 2012, petroleum imports made up 6 percent of gross domestic product (GDP). Electricity demand outstrips supply. Peak demand for electricity in 2016 was about 153 MW, but Lesotho's only functional hydropower plant, Muela, has a capacity of just 72 MW. Peak demand is expected to grow to 304 MW by 2020 and 432 MW by 2030. The Lesotho Electricity Company (LEC) forecasts that it must import over 282 GWh of electricity from South Africa (Eskom) and Mozambique (EDM) in 2016-2017 at prices, which range from Maloti (M<sup>10</sup>) 0.77 to 1.50 per kWh, substantially higher than purchases from Muela (M 0.13 per kWh). In 2015, electricity imports amounted to 66 percent of LEC's supply costs.

## **Rapidly declining biomass stock**

Deforestation is a serious problem in Lesotho. From 1990 to 2010, the country lost forest cover at the rate of 0.5 percent a year, largely because of rural household demand for wood fuel.<sup>11</sup> In 2012, Lesotho's forested areas made up only about 1.6 percent of the country's land area. With the demand for wood outpacing its supply, Lesotho has begun importing wood fuel and households turn to substitutes such as crop waste, dung, and Liquid Petroleum Gas (LPG). The use of crop waste and dung for heating and cooking deprive agricultural land of manure, contributing to a loss of

---

<sup>6</sup> The UN Secretary-General's Advisory Group on Energy and Climate Change (AGECC) defines modern energy sources as fuels such as natural gas, liquid petroleum gas (LPG), diesel and biofuels such as biodiesel and bioethanol; or technology, such as improved cooking stoves, that can enable cleaner and more efficient delivery of traditional fuels. AGECC, "Energy for a Sustainable Future," April 2010.

<sup>7</sup> International Energy Agency, World Energy Outlook, "WEO – Modern Energy for All: Why it Matters," accessed February 16, 2017, available:

<<http://www.worldenergyoutlook.org/resources/energydevelopment/modernenergyforallwhyitmatters/>>.

<sup>8</sup> Electricity access is assumed for any household responding that electricity is their main source of fuel for lighting in the 2016 national census.

<sup>9</sup> African Clean Energy, "Summary Statistics Overall," accessed February 15, 2017, available <<https://share.geckoboard.com/dashboards/3AB67CC423C6D402>>, 2015.

<sup>10</sup> 1 M = 0.07 United States Dollars (US\$) as of 1 November 2017.

<sup>11</sup> Lesotho Ministry of Energy and Meteorology, "Lesotho's Intended Nationally Determined Contributions (INDC)," 2015.



soil fertility.<sup>12</sup> Other fuels LPG are considerably more expensive, can put strains on household budgets. Households that still gather wood now spend more time and travel greater distances to collect it, a burden that disproportionately falls on women.

### 1.3 Renewable Energy in Lesotho

Lesotho is fortunate to have an abundance in solar, wind, and hydropower resource potential that well surpasses its relatively modest energy needs. Realizing the potential of these resources is a focus of the Government's *Vision 2020* strategy and viewed to be a potential catalyst for job creation and growth in private sector investment. Investment in RE is viewed as a means for addressing many of the energy sector challenges faced by Lesotho. Increased generation capacity from utility-scale solar photovoltaics (PV), wind, and hydropower could reduce Lesotho's dependence on imports from South Africa. While decentralized technologies powered by solar, wind, or biomass could bring access to modern energy services to the Basotho who currently rely on biomass and kerosene to meet their energy needs.

The GoL, with the help of development partners has made some progress in RE development. Lesotho's main source of power generation is the 72MW Muela hydropower plant. There is a small 281kW solar photovoltaic (PV) installation at the Moshoeshoe I International Airport and several small hydropower plants in the country.

Despite the significant potential, larger scale developments and private sector investment have not materialized. The constraints limiting RE development in Lesotho include:

- **Regulatory and institutional barriers** such as an incomplete legal and regulatory framework, overlapping institutional mandates of various energy sector entities, and the lack of technical standards on RE installations and appliances that creates an uncertain investment climate for RE investors and development;
- **Technical and capacity barriers** such as irregular, outdated, and incomplete renewable energy resource and energy baseline studies and limited knowledge and capacity from the institutional to the end-user level which hinders RE uptake;
- **Environmental barriers** such as declining biomass stock, increasingly variable rainfall and periods of drought, and limited availability of suitable land for RE development increases the cost of RE deployment;
- **Financial barriers** such as limited access to financing and underdeveloped delivery mechanisms for households and private sector, and the high cost of distributing RE technologies to dispersed and remote communities in Lesotho limits the scaling-up of RE deployment; and
- **Social barriers**, in particular the lack of awareness among Basotho about the health and cost saving benefits of RE technologies limits RE uptake.

---

<sup>12</sup> B.M. Taelle, K.K. Gopinathan, and L. Mokhuts'oane, "The Potential of Renewable Energy Technologies for Rural Development in Lesotho," *Renewable Energy* 32 (2007), 609-622.

## 1.4 Proposed Investment Program for Lesotho

An assessment of technical potential for various RE technologies that can be used in Lesotho was carried out to support the preparation of the SREP IP. The results of the resource assessment are shown in Table 4.1.

**Table 1.1: Summary of RE Technical Potential**

Technology	Resource	Generation Capacity (MW) <sup>1</sup>	Annual Generation (GWh)
Utility-Scale Solar PV <sup>13</sup>	Solar	118*	372
Utility-Scale Wind	Wind	2077*	5,157
Small-Scale Hydro (<10 MW)	Water	36	193
Waste-to-Energy	City Waste	10	62
Solar Microgrids	Solar Battery	31*	85
Floating Micro-Hydro Microgrids	Water	0.50	1.75
Solar Home Systems	Solar Battery	1.2	3
Micro-Solar Technologies <sup>2</sup>	Solar	38*	92
<b>Total</b>		<b>2,311.70</b>	<b>5,965.75</b>

Note: \*Estimates for all solar PV (case 2), all wind (case 2), all solar microgrids, and all solar home system (SHS) that is possible in non-excluded areas. For other technologies, it only includes the proposed plants.<sup>1</sup> Only includes known estimated potential of solar street lights, solar water pumps and solar irrigation.

A national resource assessment with consistent data gathering techniques, analysis assumptions and methodologies has not been conducted in Lesotho. Therefore, the technical assessment was based on a variety of sources – each described in the following technology sub-sections – that are used by RE researchers and developers worldwide. The datasets used were also cross-referenced against comparable regional RE developments and isolated studies on resource potential.

<sup>1</sup> Excludes battery storage component of some technologies. <sup>2</sup> Additional information is needed to determine more specifically, the technical potential of micro-solar technologies.

Each of the potential RE resources were then evaluated against national and SREP criteria, and prioritized accordingly. The criteria reflect the Government's strategic objectives, and the clear recognition that SREP funding should be used to overcome barriers to technologies that will have the potential to have a transformative impact on the energy sector. The Government priority criteria favored technologies that

<sup>13</sup> PV refers to photovoltaic

would result in job creation, improve energy security, and promote increase private sector investment.

SREP funds will be used to support investments in two on-grid technologies (solar and small hydro) and two off-grid technologies (microgrids, SHS) that were identified through the prioritization exercise. The program consists of two core investment focused components and a third technical assistance component. Due to the different challenges and business models for the on-grid and off-grid technologies it was decided to separate the program into components for each area. A third component was added to address GoL concerns that a lack of data on project sites would limit the possibility of private sector HPP investment.

The exact financing modalities will be determined at the time of appraisal, but it is expected that:

- US\$5 million of SREP funding, in the form of a concessional loan, would be used to leverage US\$11.5 million in grants and private concessional loans (or a partial risk guarantee, PRG) from African Development Bank (AfDB), US\$7.5 million in equity contributed from the developers of a 20 MW solar PV project, and US\$6.9 million in additional financing from either a private lender or other development finance institution (DFI).
- US\$12 million of SREP funding (US\$4 million in grants, US\$8 million in concessional financing) would be used to leverage US\$ 10 million in financing from the World Bank, and US\$20 million in investment from other private sector investors in microgrids and other distributed RE technologies. These funds will be complemented by another US\$4.8 million from other donors.
- US\$1.5 million in SREP grants would be used for: an AfDB managed RE integration study (US\$0.6 million); and World Bank managed site specific pre-feasibility studies (US\$0.9 million).

The GoL will contribute by facilitating fiscal incentives for services associated with the financing plan. These incentives will possibly include: waiving corporate profit tax for the first 10 years of operation and excluding RE technology sales from VAT.

On the next page Table 1.2 shows, US\$ 18.50 million of SREP funding is expected to catalyze over four times as much investment, most of it from the private sector (as equity or debt), and the Multilateral Development Banks (MDB) co-sponsors.

**Table 1.2: Lesotho SREP IP Financing Plan**

SREP Project	SREP	WB	AfDB Private Window	AfDB	Government of Lesotho	Other DFIs	Private Sector / Sponsor Equity	Total
<b>On-Grid RE</b>								
Investment in Utility-Scale Solar PV Plant	5		10 <sup>i</sup>		0.6	TBD <sup>ii</sup>	14.4 <sup>iii</sup>	30
RE Integration Study	0.6							0.6
Resource mapping study						1.4 <sup>iv</sup>		1.4
Project Implementation Support + Site Studies				1.5 <sup>ii</sup>				1.5
<i>Subtotal: On-Grid RE</i>	<i>5.6</i>		<i>11.5</i>		<i>0.6</i>	<i>1.4</i>	<i>14.4</i>	<i>32.1</i>
<b>Distributed RE Solutions</b>								
Investment in microgrids	8	6			4.1	3.2 <sup>iv</sup>	15	36.3
Investment in distributed RE technologies	4	4			1.8	2.6 <sup>v</sup>	5	17.4
Small Hydropower plants (SHPP) technical support	0.9							0.9
<i>Subtotal: Distributed RE Solutions</i>	<i>12.9</i>	<i>10</i>			<i>5.9</i>	<i>5.8</i>	<i>20</i>	<i>54.6</i>
<b>Grand Total:</b>	<b>18.5</b>	<b>10</b>		<b>11.5</b>	<b>6.5</b>	<b>7.2</b>	<b>34.4</b>	<b>86.7</b>
<b>SREP Leverage</b>	<b>4.68</b>							

Note: i) Financing instrument/AfDB window has yet to be determined. Two options being considered are to provide direct project financing through the AfDB private sector window or use an AfDB PRG to attract other private sector or DFI financing; ii) Project implementation support and site studies will be funded through a grant from the AfDB managed Sustainable Energy for Africa (SEFA) fund. iii) Total private sector contributions include sponsor equity (US\$7.5 million). The remaining US\$6.9 million could come from a private financial institution or DFI; iv) Government of Italy; v) EU US\$2.3 million + UNDP-GEF US\$0.9 million; vi) EU US\$2.3 million + UNDP-GEF US\$0.3 million.



## 2 Country Context

The Kingdom of Lesotho is a mountainous country in Southern Africa. Roughly 80 percent of Lesotho’s land is more than 1,800 meters above sea level; the average elevation is 2,161 m.<sup>14</sup> Sixty percent of the land is within the Drakensburg and Maloti mountain ranges.<sup>15</sup> The country’s three river system consisting of the Senqu, Mokhare and Makhaleng rivers represents a significant freshwater resource. Lesotho is divided into four agro-ecological zones—lowlands, foothills, Mountains, and the Senqu River Valley—and ten administrative districts.<sup>16</sup> The administrative districts are further divided into 80 constituencies, each represented by a single seat in the National Assembly. The map in Figure 2.1 displays the ten administrative districts in Lesotho, overlaid on the four ecological zones. The chart in Figure 2.1 shows the population of each district. The most populous districts overlay the lowlands and the foothills; the least populous districts are in the mountains.

**Figure 2.1: Administrative Districts in Lesotho**

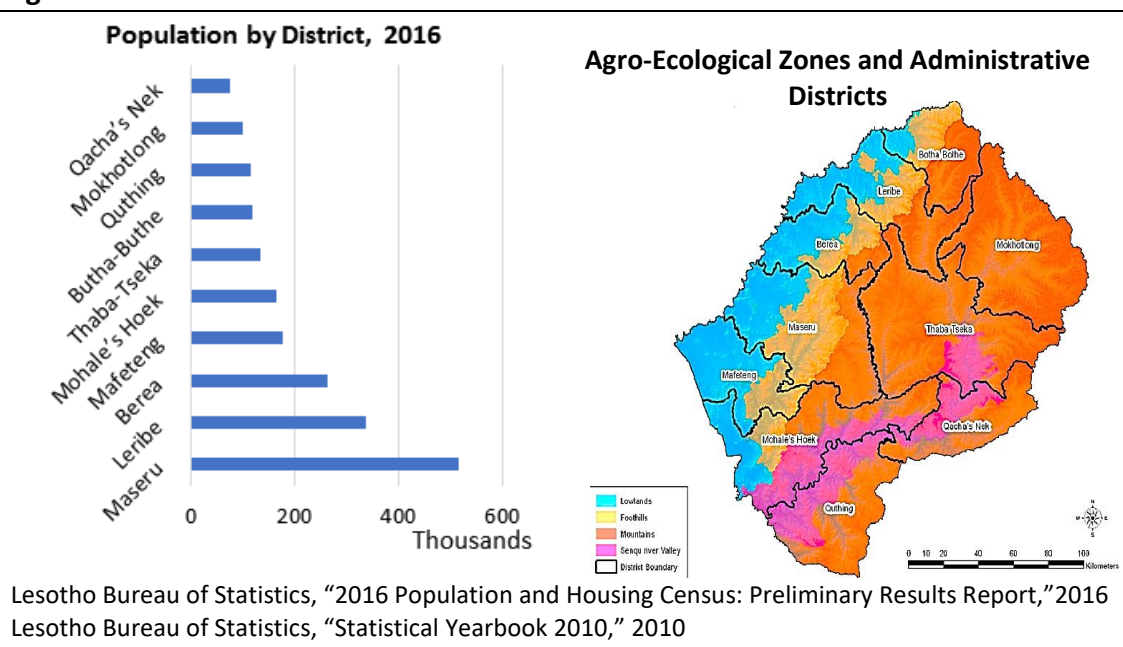

### Demographics

Lesotho has a population of two million people.<sup>17</sup> More than 99 percent of the population are ethnic Basotho.<sup>18</sup> Sixty-four percent of Basotho live in the districts of Berea, Leribe, Maseru, and Mafeteng, in the arable lowlands. The remaining population lives in six districts that include the Senqu River Valley and comparatively more mountainous land.

Population growth has slowed since the early 1990s, from two percent a year to slightly more than one percent. Most people live in rural areas but, as shown in Figure

<sup>14</sup> GoL, “2016 Population and Housing Census Preliminary Results Report”, 2017.

<sup>15</sup> Lesotho Meteorological Services, “Climate Change in Lesotho: A Handbook for Practitioners”, 2001.

<sup>16</sup> The ten administrative districts in Lesotho are: Berea, Botha-Bothe, Leribe, Mafeteng, Maseru, Mohale’s Hoek, Mokhotlong, Qacha’s Nek, Quthing and Thaba-Tseka.

<sup>17</sup> “World Development Indicators,” World Bank, accessed January 25, 2017.

<sup>18</sup> The term “Basotho” also refers to the demonym for Lesotho.

2.2, the share of the urban population has increased substantially, from 14 percent in 1990 to 27 percent in 2015.

**Figure 2.2 Population Composition, 1990 – 2015**

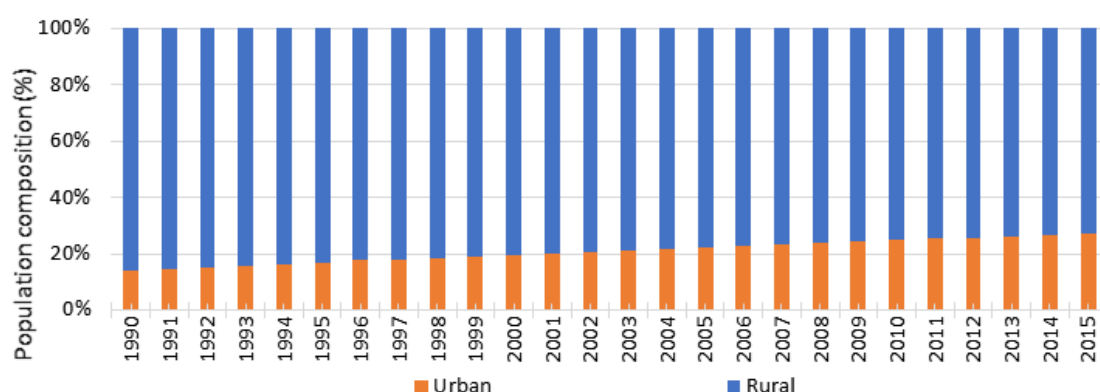

Source: World Bank World Development Indicators.

### Socio-economic challenges and opportunities

Lesotho’s economy, once based on remittances and agriculture, is now driven by value-added output in services. Some of the largest industries in Lesotho are mining, construction, food products, and textiles; in services wholesale and retail trade. As shown in the rightmost chart in Figure 2.3, agriculture’s value addition to Lesotho’s economy declined from 41 percent in 1975 to 6 percent in 2015. Remittances declined from nearly 100 percent of GDP in the early 1980s to just 16 percent in 2015.

**Figure 2.3: Structural Changes to the Economy of Lesotho, 1975 – 2015**

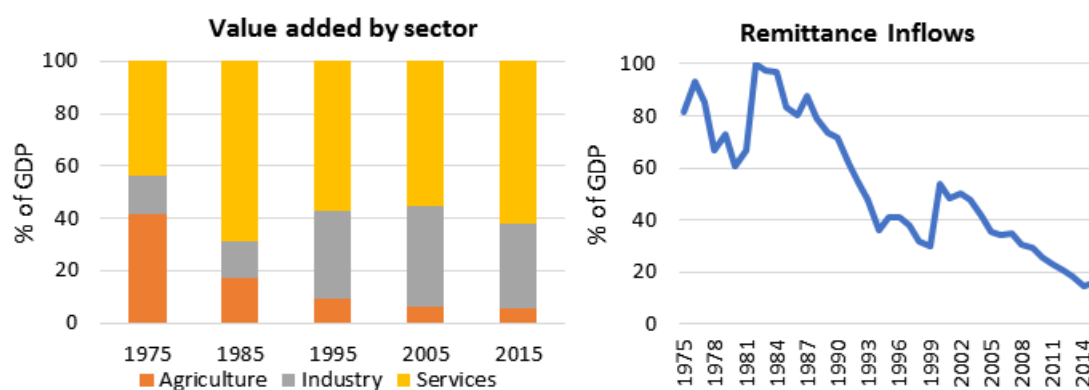

Source: World Bank World Development Indicators.

These structural changes to the economy have been accompanied by modest economic growth. As shown in Figure 2.4 economic growth in Lesotho has been positive since 2005 but susceptible to external shocks. The country quickly recovered from the global financial crisis in 2009, but growth has stagnated since 2011 because of slow economic growth in South Africa and increasingly volatile revenues from the Southern African Customs Union.<sup>19</sup> In 2015, GDP was 23.7 billion M and per capita GDP

<sup>19</sup> International Monetary Fund, “IMF Country Report,” 2016.

was M 12,327 (about US\$ 920)<sup>20</sup>. Figure 2.4 shows Lesotho’s GDP and compares the country’s GDP growth rates to South Africa’s growth rates in real terms since 2005<sup>21</sup>.

**Figure 2.4 Economic Growth in Lesotho and South Africa, 2005-2015**

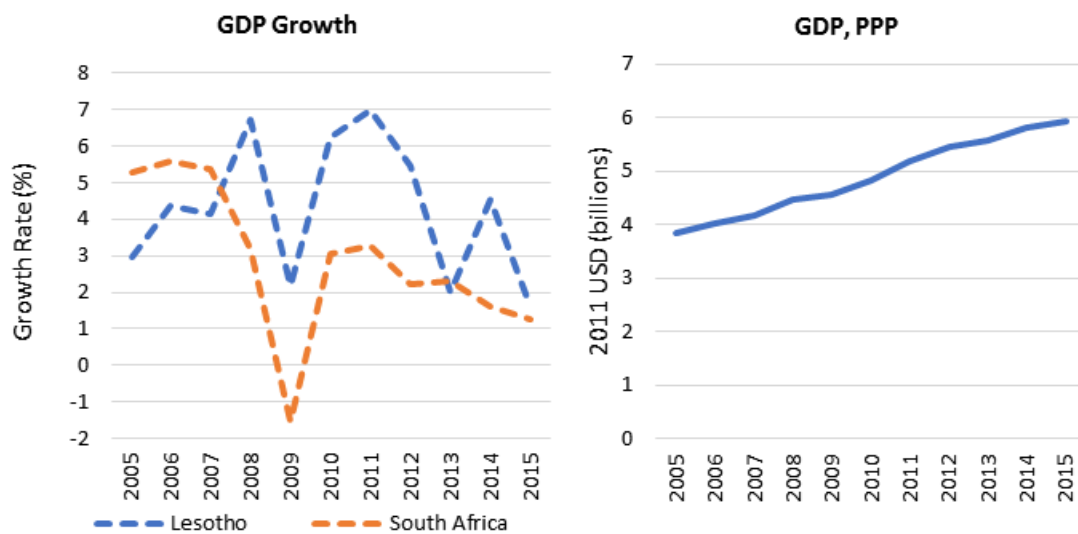

Source: World Bank World Development Indicators.

Unemployment and poverty remain critical problems in Lesotho despite the country’s steady economic growth. The unemployment rate has been consistently high: 27 percent in 1999, 35 percent in 2008, and 24 percent in 2013.<sup>22</sup> In 2015, the broad unemployment rate, which includes discouraged workers, was 28 percent.<sup>23</sup> Among the youth (ages 15 to 24)— about 20 percent of the population—unemployment was even higher, at 43 percent.<sup>24</sup> The largest formal sector employers are the Government and the textile assembly industry.<sup>25,26</sup> Other formal sectors of employment in Lesotho include mining, industry, farming, and services.<sup>27</sup> Subsistence farming is the most common form of informal employment.

The poverty rate in Lesotho is 56 percent, among the highest in Africa.<sup>28</sup> Figure 2.5 compares the poverty headcount ratio at US\$ 1.25 a day among Sub-Saharan African countries.

<sup>20</sup> Lesotho Bureau of Statistics, “National Accounts 2015”

GDP figures are in 2012 prices.

<sup>21</sup> Real term growth refers to price-adjusted value of gross domestic product.

<sup>22</sup> ILOSTAT Database (accessed February 8, 2016)

<http://www.ilo.org/ilostat>

<sup>23</sup> World Bank, “Report 97812: Lesotho – Systematic Country Diagnostic,” 2015.

<sup>24</sup> Lesotho Bureau of Statistics, “2016 Population and Housing Census: Preliminary Results Report,” 2016

<sup>25</sup> World Bank, “Report 97812: Lesotho – Systematic Country Diagnostic,” 2015.

<sup>26</sup> World Bank, “Report 97812: Lesotho – Systematic Country Diagnostic,” 2015.

<sup>27</sup> Manufacturing, including textiles, employs around ten percent of the workforce. Around seven percent of the workforce are employed in each of these sectors: mining; construction; agriculture, fishing and forestry; and retail trade. Over 40 percent of the workforce is employed in subsistence farming.

<sup>28</sup> World Bank, “Report 97812: Lesotho – Systematic Country Diagnostic,” 2015.

**Figure 2.5: Poverty Headcount Ratio at US\$ 1.25 a Day in Sub-Saharan Africa**

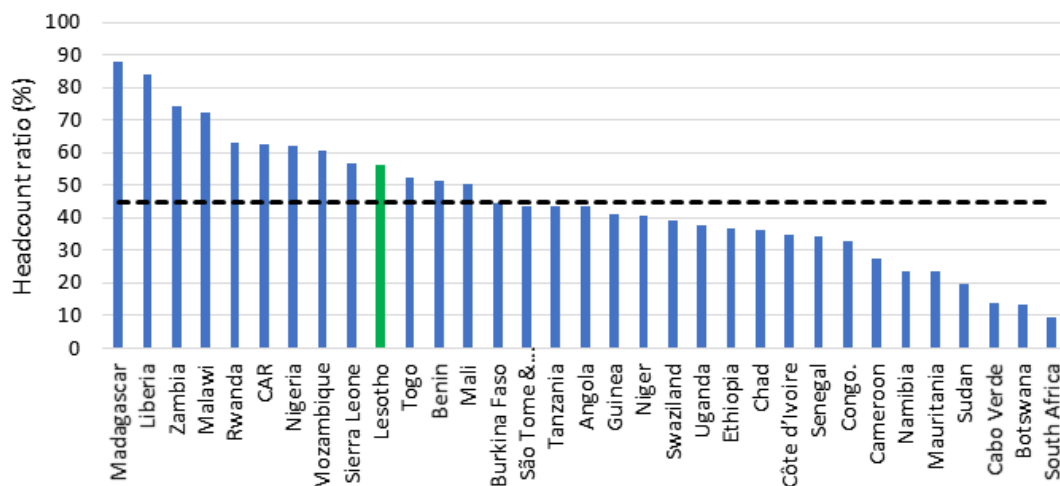

Source: AfDB, 2015. Countries limited to those reporting after 2007, and exclude Mauritius and Seychelles.  
 Note: Poverty headcount ratio is based on 2005 PPP US\$

There is also a rural-urban divide in poverty levels: 61 percent of the rural population are considered poor compared to 39 percent in urban areas. This divide can be explained by the rural population’s reliance on farming, which tends to be a low source of income. As shown in Figure 2.6 farming is the most common source of income in rural areas, at the same time, poverty rates among households headed by subsistence farmers or unpaid family workers are the highest.

**Figure 2.6: Poverty Rates and Sources of Income**

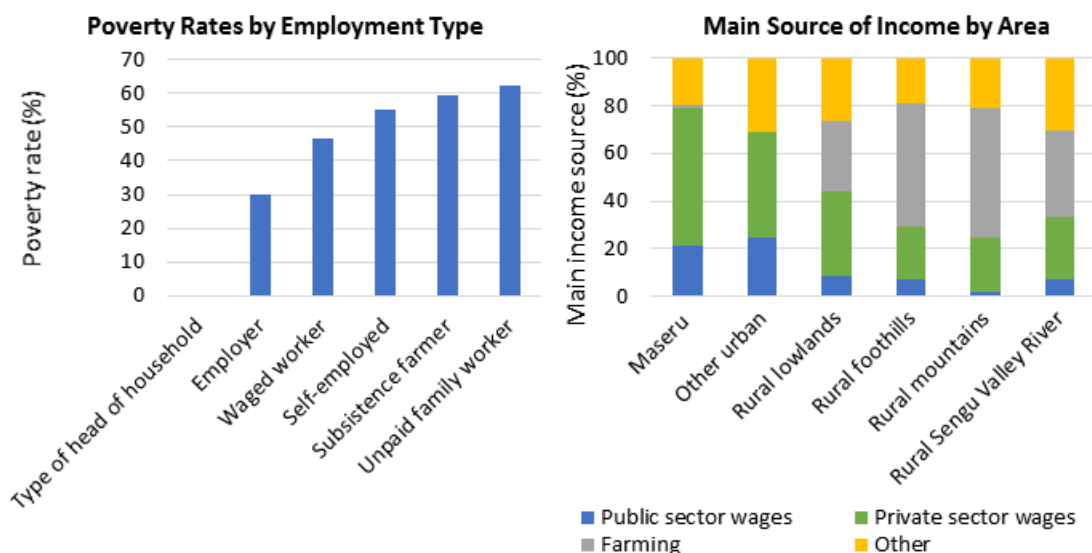

Source: World Bank, “Country Diagnostic Report”, 2015.

The GoL is keenly aware of the socio-economic challenges that Lesotho faces and has as objectives the enhancement of the Basotho skill base, the embrace of technological adoption as a foundation for innovation, and the creation of jobs for inclusive



economic growth.<sup>29</sup> Lesotho’s economic outlook is promising in the short- to medium-term. Opportunities such as the expansion of diamond mining in 2017 and phase two of the Lesotho Highlands Water Project promise to provide a capital boost to GDP.<sup>30,31</sup> In the long-term, job creation—especially for the youth—remains a key precondition for sustainable and inclusive economic development.

### Climate change adaptation and mitigation challenges

Climate change is already affecting Lesotho, which experiences variable and extreme weather conditions that the GoL expects to worsen in intensity and frequency.<sup>32</sup> By 2030, Lesotho is expected to see a 1 degree Celsius increase in annual mean temperature, and experience drier autumn and winter months and wetter spring and summers. Sectors on which Basotho livelihoods depend such as the water, agriculture, forestry, and ranching/fishing sectors will be especially susceptible to the effects of climate change.<sup>33</sup> Table 2.1 summarizes the likely impact of climate change in Lesotho.

**Table 2.1: Effects and Impact of Climate Change in Lesotho**

Sector	Extreme variations in weather	Reduced rainfall	Increasing temperature	Impact of climate change
Water	✓	✓		Droughts, water stress, water scarcity, and increased levels of water-borne diseases
Agriculture	✓	✓	✓	Increased impact of crop diseases and pests can lead to famine and loss of traditional livelihoods
Forestry		✓	✓	Reduced levels of forest cover, effectiveness of reforestation programs, and availability of traditional energy supplies
Ranching/ Fishing		✓		<ul style="list-style-type: none"> <li>▪ Weak recovery of grasses/vegetation</li> <li>▪ Reduced number/quality of livestock and production of wool, meat, and milk</li> <li>▪ Loss of traditional livelihoods</li> </ul>
Environment	✓	✓	✓	<ul style="list-style-type: none"> <li>▪ Soil erosion from extreme weather will result in decreased soil fertility, higher silt levels in rivers</li> <li>▪ Drought will result in disappearance of wetlands and reduced vegetation and eventually loss of</li> </ul>

<sup>29</sup> Government of Lesotho, “Lesotho National Vision 2020,” 2000.

<sup>30</sup> International Monetary Fund, “Country Report No. 16/33, Kingdom of Lesotho: 2015 Article IV Consultation – Press Release; Staff Report,” 2016.

<sup>31</sup> The Lesotho Highlands Development Project, established in 1986, is a joint venture between Lesotho and South Africa with the dual objective of providing water for South Africa and generating electricity for Lesotho. Phase I of the Project was completed in 2003 and involved the construction of the Katse and Mohale dams and the Muela hydropower plant.

<sup>32</sup> Lesotho Ministry of Energy and Meteorology, “Lesotho’s Intended Nationally Determined Contributions (INDC),” 2015.

<sup>33</sup> Lesotho Meteorological Services, Ministry of Natural Resources, “Lesotho’s National Adaptation Programme of Action (NAPA) on Climate Change under the United Nations Framework Convention on Climate Change,” 2015.

habitat and food for many animal and plant species

Source: Lesotho Meteorological Services, Ministry of Natural Resources, "Lesotho's National Adaptation Programme of Action (NAPA) on Climate Change under the United Nations Framework Convention on Climate Change," 2015.

---

The GoL recognizes the need to undertake adaptation and mitigation measures to ensure that Lesotho's development is not hampered by climate change. In its National Strategic Development Plan, the GoL has integrated climate change into sectoral plans and programmes, improve environmental governance, and upgrade infrastructure development standards to include climate proofing.

### 3 Overview of the Energy Sector

Lesotho’s energy mix is dominated by biomass. As shown in the leftmost chart on Figure 3.1, biomass constitutes over half of Lesotho’s energy balance. The rightmost chart on Figure 3.1 shows that most biomass derives from wood. Fossil fuels such as coal and petroleum also make up a substantial portion of Lesotho’s energy mix while electricity contributes very little. Since Lesotho has no proven reserves of oil or gas, it imports nearly all its fossil fuel from South Africa. Because of dwindling forest reserves Lesotho has also started importing fuelwood to meet energy demand needs. In 2012, fuel imports accounted for 13 percent of total trade from South Africa, and 7 percent of Lesotho’s GDP.<sup>34</sup>

**Figure 3.1: Energy Demand and Supply<sup>35</sup>**

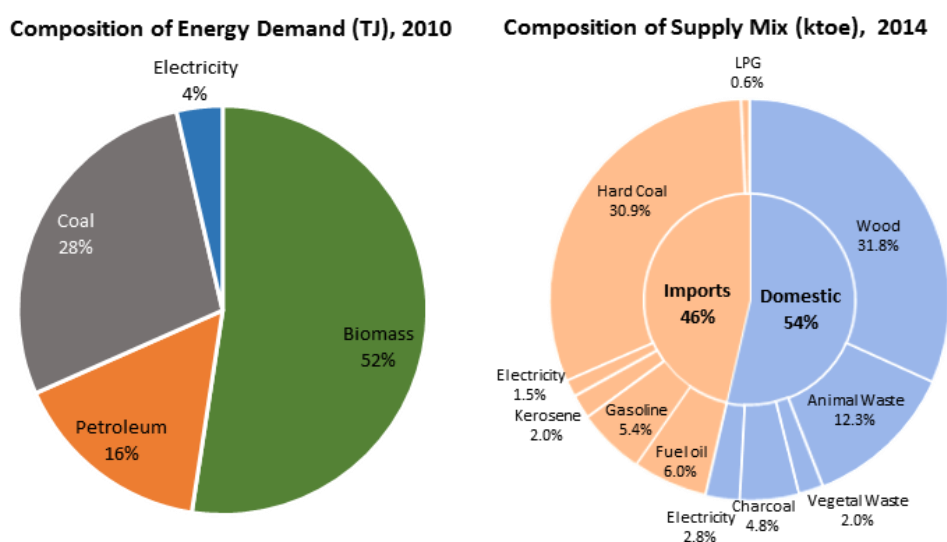

Source: Lesotho Bureau of Statistics, “2010/2011 Household Budget Survey Analytical Report Volume 1,” 2014, and United Nations Statistic Division, “Energy Statistics Database” 2017

The residential sector is the largest consumer of energy by far. Figure 3.2 shows Lesotho’s final energy consumption by sector and source. The pie chart on the right of Figure 3.2 shows the residential sector’s fuel consumption by source. Biomass and coal provide more than 90 percent of households’ consumption by energy content.

<sup>34</sup> UN Comtrade Database, accessed February 14, 2017, <https://comtrade.un.org/data/>

Data derived from SITC revision 2 classification; since Comtrade uses current dollar values, the GDP comparison is based on current 2012 values. In terms of constant PPP US\$, fuel imports represent 3% of Lesotho’s GDP.

<sup>35</sup> Data from the Lesotho Bureau of Statistics have no values for LPG consumption. Data from the United Nations Statistics Division (UNSD) Energy Statistics Database contain estimates for fuel production and imports by weight. These weights are converted into their energy content using rough estimates. Data are not available for fuelwood imports.

**Figure 3.2: Final Energy Consumption by Sector and Source (TJ), 2010**

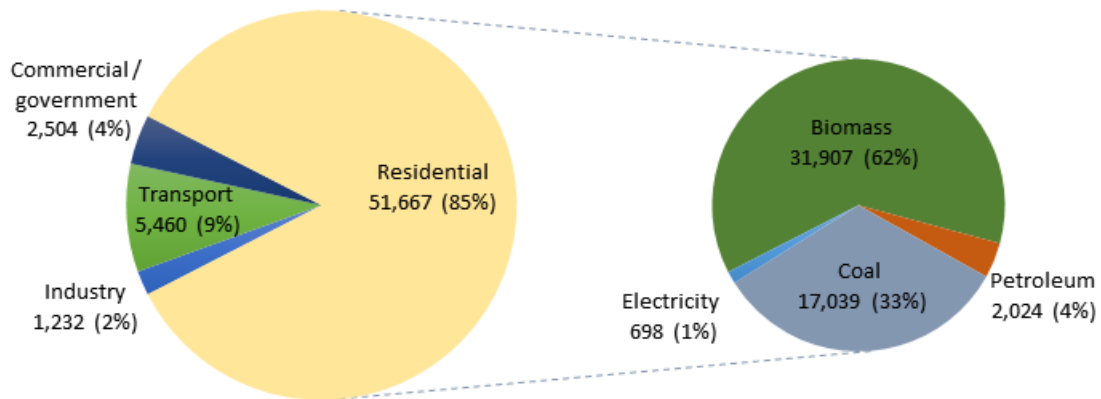

Note: Data do not include consumption by the agricultural sector or data of LPG consumption.

Source: Lesotho Bureau of Statistics, "2010/2011 Household Budget Survey Analytical Report Volume 1," 2014.

Because many households in Lesotho lack access to electricity (38 percent in 2016), they rely on traditional fuels such as biomass for their energy needs. Biomass (wood and dung) is used for cooking and heating, especially in rural areas. Urban households are less reliant on biomass and mainly use paraffin and gas for heating and cooking. Paraffin (kerosene) is the main source of fuel for lighting: 60 percent of all households use paraffin while the rest use electricity or candles.<sup>36</sup> Figure 3.3 shows the main sources of heating, cooking, and lighting used by households in Lesotho.

**Figure 3.3: Sources of Heating, Cooking, and Lighting for Households in Lesotho**

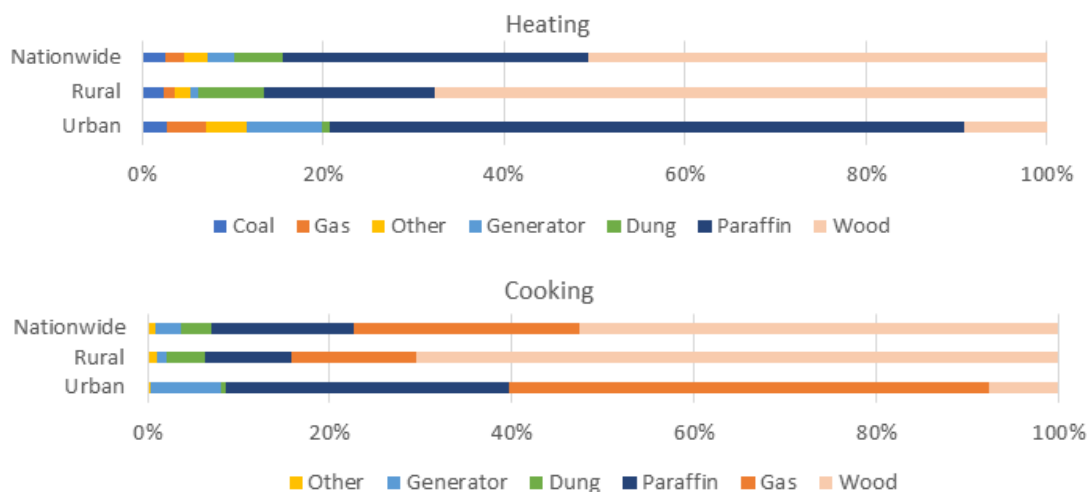

<sup>36</sup> Lesotho Bureau of Statistics, "2011 Lesotho Demographic Survey: Analytical Report, Vol. 1," 2011.

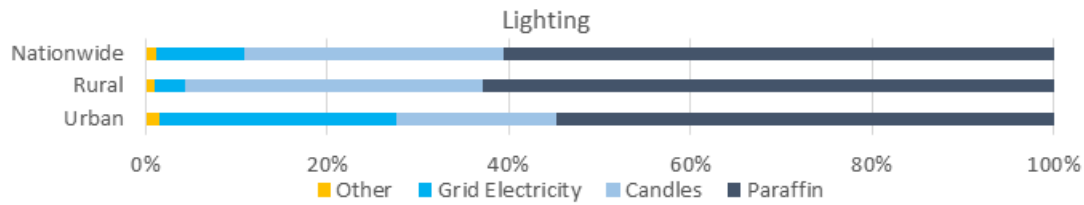

Note: Other: Heating (Solar, Gas, and Crop waste); Cooking (Solar, Coal, and Crop waste); Lighting (Generator, Solar, Battery, and Gas)

Source: Bureau of Statistics, "Environment and Energy Statistics Report," 2012

The GoL recognizes that the low electrification rate, reliance on imported fuels, and dwindling forest reserves are fundamental challenges in the energy sector and barriers to economic development. In its Vision 2020 strategy, the GoL has set goals to expand electricity access and promote the use of RE sources by 2020. The GoL has also included in its National Strategic Development Plan from 2014 to 2017 a commitment to promoting the safe use of biofuels, reversing environmental degradation, and increasing the use of RE sources to increase energy security.

The following sections provide more details on the energy sector. Section 3.1 provides an overview of the institutional, legal, and regulatory framework of the energy sector, and sections 3.2 (supply) and 3.3 (demand) provide an overview of the electricity sector. Section 3.4 summarizes the key challenges facing the energy sector.

### 3.1 Institutional, Legal, and Regulatory Framework

The GoL envisions the energy sector playing an important role in the strategic development of the country. Lesotho's **Vision 2020 (2004)** is an overarching framework for the country's development by the year 2020, identifying seven pillars: democracy, unity, peace, education and training, economic growth, management of the environment, and advancement in technology. Vision 2020 foresees the development of electricity networks as an important component in establishing strong economic infrastructure in Lesotho, and it calls for expanding electricity access to households. RE is also a major component of this vision, and is intended to contribute to electrification and environmental goals.

The **National Strategic Development Plan (NSDP) 2012/13 to 2016/17 (2012)** serves as an implementation strategy for Vision 2020. The NSDP was implemented to align GoL strategy over a five-year period across six strategic goals<sup>37</sup> related to Vision 2020 objectives. In the energy sector, the NSDP calls for increased clean energy production to attain self-sufficiency and export potential; expanded electricity access; and better, more efficient use of domestic energy resources.

The following sub-sections summarize the institutional, legal, and regulatory framework in the energy sector. Section 3.1.1 provides information on important institutions in the energy sector, including those responsible for policy, regulation,

<sup>37</sup> The goals are: create high, shared, and employment-generating growth; develop key infrastructure; enhance skills base, technology adoption, and foundation for innovation; improve health, combat HIV and AIDS, and reduce vulnerability; reverse environmental degradation and adapt to climate change; and promote peace, democratic governance, and effective institutions

generation, transmission, distribution, and electrification. Section 3.1.2 summarizes key energy sector policies, legislation, and regulations in the energy sector of Lesotho.

### **3.1.1 Institutional framework in the electricity sector**

The **Ministry of Energy and Meteorology (MEM)** is responsible for overall policymaking and financial planning in Lesotho's energy sector. The **Department of Energy (DoE)**, part of MEM, is responsible for coordinating, monitoring, and evaluating programs and activities in the energy sector. The DoE has three divisions: conventional energy, RE, and planning. Each division is responsible for collecting data on sector activities and supporting coordination among stakeholders relevant to their focus area.

The state-owned **LEC** is Lesotho's monopoly electricity transmission, distribution, and bulk electricity supply company. LEC imports electricity from South Africa's state-owned electricity company, ESKOM, and can import and export electricity via the Southern African Power Pool. While LEC does own, and operate a few SHPP attached to its distribution network, the only significant domestic generation comes from the Muela hydropower plant (MHP) operated by the **Lesotho Highlands Development Authority (LHDA)**. The LHDA is responsible for the implementation, operation, and maintenance of Lesotho's portion of the Lesotho Highlands Water Project (LHWP), a water (jointly with South Africa) and hydropower generation (Lesotho only) project.

**Lesotho Electricity and Water Authority (LEWA)** is the economic regulator for the electricity sector, created in 2002. Its mandate was expanded in 2011 to regulate the water sector. LEWA is responsible for issuing licenses for electricity supply activities; setting tariffs for generation (including feed-in tariffs), transmission, distribution, and supply; regulating the quality of supply; and resolving disputes. LEWA also monitors the single buyer of renewable electricity (LEC) and manages the UAF.

Rural electrification efforts involve a mix of sector institutions. LEC is responsible for rural electrification projects within its service territory (within 3.5 km from the existing distribution network). The **Rural Electrification Unit (REU)**, established in 2004, is a project implementation unit under the DoE that coordinates and manages the implementation of off-grid and rural electrification projects outside the LEC service area. REU projects are funded through a Universal Access Fund (UAF) that is managed by LEWA.<sup>38</sup>

### **3.1.2 Key energy sector policies, laws, and regulations**

The main document that has been developed to guide the strategic vision of the energy sector is the **Lesotho Energy Policy 2015-2025**. This policy aims to align energy sector policy with the goals described in Vision 2020 and the NSDP. The 15 policy statements in the document aim to reliably and affordably ensure energy access to improve the economy of Lesotho and the livelihoods of its citizens. Policy objectives include: introduction of an appropriate institutional and regulatory framework for the sector; sufficiency and availability of energy sector data; sustainability of bioenergy resources; improved access to RE services and technologies; promotion of energy efficiency; security of electricity supply; development of a reliable and efficient

---

<sup>38</sup> The UAF receives funding from the Gol and international donor partners.

transmission network; increased access to electricity for all socio-economic sectors; development of a transparent and competitive electricity market; creation of an enabling environment attractive to investment and financing; and introduction of a transparent price-setting structure that ensures cost recovery.

Although not specifically an energy sector policy, Lesotho’s **Intended Nationally Determined Contributions (INDC) (2015)** includes several energy related objectives as part of the country’s commitments towards mitigating and adapting to climate change. Committed actions related to the energy sector include: continued development of hydropower resources; implementation of demand-side management techniques to ensure efficient use of existing distribution infrastructure; promotion and development of RE, particularly wind and solar; improved distribution efficiency; and development of a low energy IP. Lesotho’s INDC also sets certain targets for the energy sector including targets to improve energy efficiency, increase electricity coverage, and increase RE generation by 2020

Lesotho does not currently have an Energy Act in place that formally enacts energy policy and establishes the mandates of sector institutions. As part of an ongoing EU capacity building program, the DoE is planning to formulate an Energy Act in 2018. Absent an overarching law the sector is currently governed through several pieces of legislation. Table 3.1 provides an overview of important energy sector laws in Lesotho.

**Table 3.1: Key Sector Legislation**

Legislation	Overview
Lesotho Establishing and Vesting Act (2006)	Establishes the Lesotho Electricity Corporation as the Lesotho Electricity Company, vested with all of its assets, liabilities, rights, and obligations as the national electricity transmission and distribution company
Lesotho Electricity Authority (LEA) Act (2002)	Establishes the Lesotho Electricity Authority as regulator for electricity sector
LEA Amendment Act (2006)	Amends LEA Act (2002) regarding composition of Board, funding, powers to enter and use land for regulated activities, and acquisition of land required for regulated activities
LEA Amendment Act (2011)	Amends LEA Act (2002) to give the Authority power to regulate Lesotho’s water and sanitation sector and renaming the regulator as the Lesotho Electricity and Water Authority
Fuel and Services Control Act (1983)	The Act empowers the Minister to impose and collect a levy on fuel, except paraffin

The LEA act 2002 give LEWA the authority to draft economic regulations for the electricity and water sector. The Ministry of Energy is responsible for approving the regulations. Table 3.2 summarizes important regulations in the energy sector in Lesotho.



**Table 3.2: Key Regulations and Guidelines**

Regulation	Purpose
Electricity Price Review and Structure Regulations (2009)	Regulates reviews of tariff structure and prices
License Fees and Levies Regulations (2009)	Regulates funding Regulator activities via licensing fees and customer levies
Resolution of Disputes Rules (2010)	Regulates dispute resolution between licensees and between licensees and customers
UAF Rules (2011)	Establishes a fund for electrification and sets administrative rules
Application for Licenses Rules (2012)	Sets procedures and requirements for license applications and exemptions

Although a formal RE regulatory framework has not been adopted, the AfDB and EU are supporting an elaboration of the regulatory framework in the electricity sector. In 2015, LEWA, with the support of AfDB, developed a draft Regulatory Framework for the Development of Renewable Energy Resources in Lesotho (“RE regulatory framework”) for expanding the use of renewable energy resources. The framework specifies the procurement and regulatory approaches for both on-grid and off-grid RE. Specifically, the RE regulatory framework includes: feed-in-tariff rules; procurement guidelines; and templates for various licenses, tenders, and power purchase agreements (PPAs). The proposed regulatory framework has not been adopted by Government, but LEWA has published the PPA template to guide prospective power producers and off-takers who are interested in buying or selling electricity to the Lesotho grid. The GoL will look to formally adopt many of the components of the framework as part of the Energy Act that is planned for 2018.

The EU, as part of its technical assistance to the DoE is assessing the regulatory framework’s robustness to support private sector participation in off-grid electrification and eventual integration to the main grid.

### 3.2 Electricity Supply

Lesotho’s electricity system has nearly 76 MW of installed capacity, most of which comes from the 72 MW MHP. The MHP is owned and operated by the LHDA, and only produces electricity when water is sent through the plant to be delivered to South Africa. LEC also owns four micro-hydropower plants: Semonkong and Mantsonyane,, but only the Semonkong plant is operational, as work is still ongoing in Mantsonyane to remove slit that is trapped in the pond.<sup>39</sup> A backup diesel generator produced most of the electricity at the Semonkong plant during the 2015-2016 period because of drought.<sup>40</sup> The LHDA owns one micro-hydropower plant (HPP), the 540 kW Katse HPP. Table 3.3 shows the generation assets in Lesotho.

<sup>39</sup> “Generation”, Lesotho Electricity Company (Pty) Ltd, accessed February 16, 2017, available <<https://www.lec.co.ls/generation>>

<sup>40</sup> Lesotho Energy Company (Pty) Ltd., “LEC Annual Report 2015-2016,” 2016,.

**Table 3.3: Generation Assets in Lesotho**

Asset	Connection	Technology	Installed Capacity (MW)	Available Hydro Capacity
Muela	Grid	Hydro	72	72
Mantsonyane	Grid	Hydro	2	2
Katse	Grid	Hydro/diesel	0.54 (0.8*)	0.54
Semonkong	Off-grid	Hydro/diesel	0.18 (0.4*)	0.18
		<b>Total capacity</b>	<b>74.72(hydropower only)</b>	<b>74.72</b>

Note: \* Capacity of backup diesel generators.

Sources: Wim Jonker Klunne, Council for Scientific and Industrial Research, "Small hydropower in Southern Africa - an overview of five countries in the region", 2013, and LHDA, "Annual Report 2002/2003", 2002, 20

Transmission and distribution lines in Lesotho are owned by LHDA and LEC. LHDA owns the transmission and distribution lines that were developed under Phase I of the LHWP. LEC owns and operates the transmission and distribution lines in the rest of the country, which includes 132 kV, 88 kV, 66 kV, 33 kV and 22 kV transmission lines. The LEC also owns 132 substations in Lesotho, with 75 distribution substations located in Maseru.<sup>41</sup>

### Electricity imports

Lesotho imports 36 percent of its electricity needs from the South African electricity supplier, ESKOM, and Mozambican electricity supplier Electricidade de Moçambique (EDM).<sup>42</sup> Imports decreased from 310 GWh in 2012 to 280 GWh in 2015, but are increasingly used to meet peak demand—roughly 55 percent of imports are used to meet peak demand. Figure 3.4 shows LEC's bulk purchases, by origin.

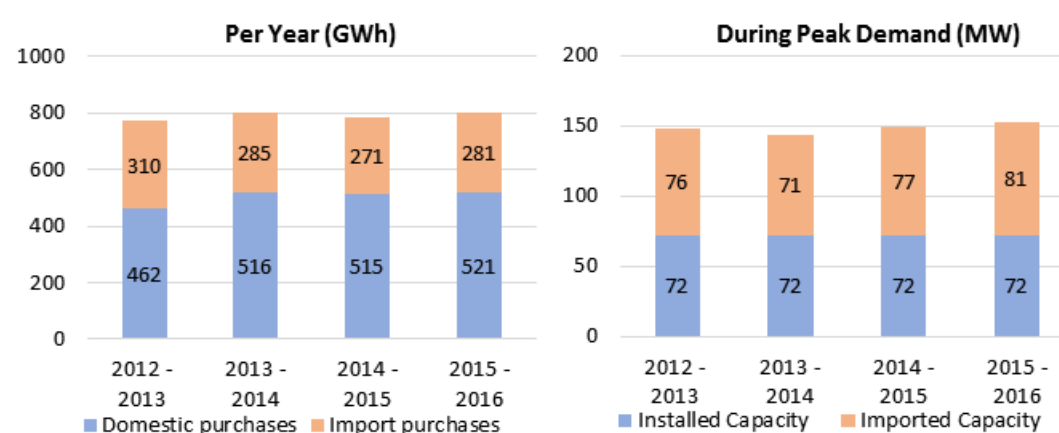
**Figure 3.4: LEC Purchases, 2012 - 2016**

<sup>41</sup> Thuloane B. Tsehlo, United Nations Economic Commission for Africa, "Assessment of energy for rural development in Lesotho," 2012.

<sup>42</sup> Lesotho Electricity Company (Pty) Ltd, "Annual Report 2015-2016," 2016.

Between April 2015 and March 2016, LEC imported around 280 GWh of electricity from South Africa and Mozambique. As shown in Figure 3.5, 31 percent of annual imports were purchased in the summer, between January and March because these months coincide with the rainy season, when South Africa is less reliant on water imports from Lesotho and less water flows through the Muela power plant.

**Figure 3.5: LEC Bulk Purchases by Intake Point, April 2015 to March 2016 (GWh)**

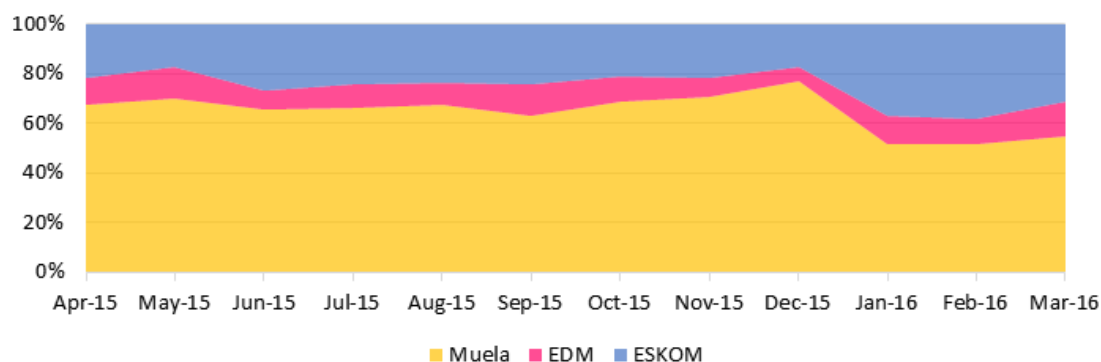

Source: LEC, “Annual Report 2015-2016”, 2016.

### Electricity cost and tariffs

As described in section 3.1.1, one of LEWA’s responsibilities as the economic regulator is to set end-user electricity tariffs. LEWA has several regulations that outline its tariff-setting principles and filing procedures. The revenue requirement for LEC is set using a rate-of-return approach.<sup>43</sup> Electric companies have the option to submit single- or multi-year tariff proposals—although LEC has historically filed for tariff changes each year. LEC uses a single-part variable tariff (per kWh) for residential, general purpose, and street lighting customers and a two-part tariff (with fixed and variable charges) for commercial and industrial customers.<sup>44</sup> All electricity consumers also pay customer and electrification levies per kWh on top of the variable portion of the tariff. The customer levy covers a portion of LEWA’s operating costs and the electrification levy funds REU’s electrification projects.

LEWA is in the process of hiring consultants, with the support of AfDB, to conduct a cost of service study that will be used to design tariffs based on the principal of cost causation. Absent this information, tariff increases have recently been applied uniformly across all tariff classes regardless of the cost LEC incurs to serve each class. Figure 3.6 shows the variable tariff paths for the past eight years. Tariffs have increased, on average, 11 percent per year over this period.

<sup>43</sup> Under the rate-of-return approach, a utility’s costs of service are assumed to include operating and maintenance expenses, depreciation expenses, and an allowed rate of return on invested capital (often referred to as the “rate base” or “regulated asset base”).

<sup>44</sup> General purpose customers include certain social service institutions such as schools and churches as well as small and medium size enterprises (SMEs).

**Figure 3.6: Variable Tariff Path, 2007-2017**

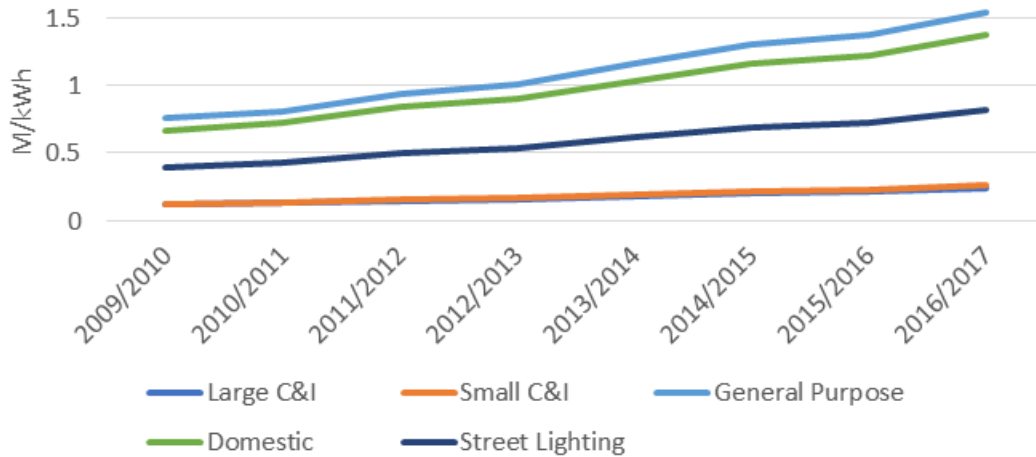

The tariff-setting process has shown to provide a sufficient level of revenue for LEC to cover its annual operating costs. LEC operated with a net profit of M 56.3 million (US\$ 4.35 million) in 2015/2016. As shown in Figure 3.7, the average tariff approved was sufficient to cover *actual* cash operating cost per kWh delivered in four of the past six years. These results show that tariffs are currently being set at levels that allow LEC to cover its cash operating expenses, but it is unclear whether LEC is earning a sufficient return on its investments. Until their 2017/2018 tariff application, LEC did not have an asset registry to submit with their annual tariff filings, as required in LEWA’s filing procedures. Without an asset registry LEWA did not have enough information to determine LEC’s regulatory asset base and was forced to set the return on asset discretionally each year.<sup>45</sup> The lack of an asset registry also has meant that LEWA has not had sufficient information to verify the depreciation cost LEC includes in its annual filings.<sup>46</sup> Now that LEC has completed the asset registry it is anticipated the tariff will include a return on assets based on the actual regulatory asset base—and thus will be fully reflective of costs going forward. Figure 3.7 shows LEC’s cost of service from 2010/11 to 2015/2016.

<sup>45</sup> In the rate-of-return approach capital investment costs are intended to be recovered through both the depreciation and return on asset components included in the revenue requirement.

<sup>46</sup> Despite not having sufficient information to verify costs LEWA has annually approved LEC’s depreciation requests. This has been done with the intention of ensuring LEC had sufficient revenue to cover capital maintenance. LEWA has ordered LEC to maintain a ring-fenced depreciation account to allow for proper monitoring of how depreciation revenue is being used.

**Figure 3.7: LEC's Cost of Service from 2010-2016**

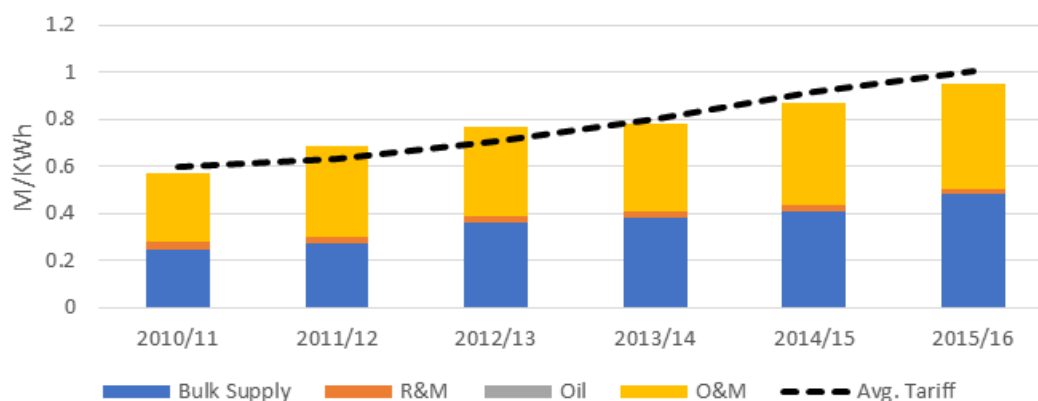

Note: Annual costs are the actual costs reported in the subsequent year's tariff determination. For example, the 2014/2015 costs were taken from LEWA's 2015/2016 LEC Tariff Determination report.

The most important omission in the current tariff scheme is a lack of any social protections for low income domestic customers. As the delivery network expands into rural areas, households may now have the opportunity to receive electricity service but may not be able to afford even a basic level of consumption. At 2016/2017 tariff levels, the cost of 50 kWh represents at least 10 percent of monthly income for nearly half the households in the country.<sup>47</sup> Connection fees, currently M 2,000 (US\$155) are another obstacle the could prevent the poor from gaining access to electricity.

### 3.3 Electricity Demand

Average per capita consumption of electricity in Lesotho is 253 kWh, about half the Sub-Saharan African average of 488 kWh, but has been growing at an average of three percent a year since 2009 because of new household connections.<sup>48</sup> The commercial and industrial sectors have been the largest consumers of electricity, accounting for 65 percent of LEC sales while residential consumption (34 percent) and other general purpose (one percent) made up the remainder of sales in FY2015, as shown in Figure 3.8.

<sup>47</sup> A 2010 Household Budget Survey (HBS) conducted by the BoS shows that 68 percent of the households earn less than M 1,000 per month.

<sup>48</sup> World Bank, "World Development Indicators: Electricity Consumption per Capita", 2013.

**Figure 3.8: Yearly Electricity Sales by Customer Class, 2009-2015 (GWh)**

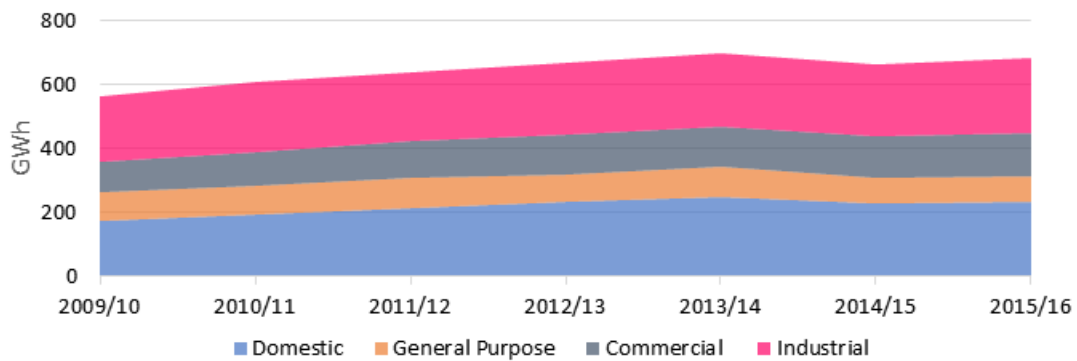

Source: LEC

Electricity demand peaks during the winter months of June to August, when there is high demand for heating, and is lowest in the summer. Daily demand peaks around 0900 hours, as operations in the commercial and industrial sectors commence. A second peak is observed around 1900 hours, driven by domestic activity such as television, radio, and lighting. Figure 3.9 shows peak demand for electricity by month and hour. The monthly chart also contains the average hourly generation per month from the Muela power plant during the 2015-16 period. Across the year, domestic generation meets about half of Lesotho’s peak energy demand.

**Figure 3.9: Average Peak Electricity Demand, 2010-2016 (MW)**

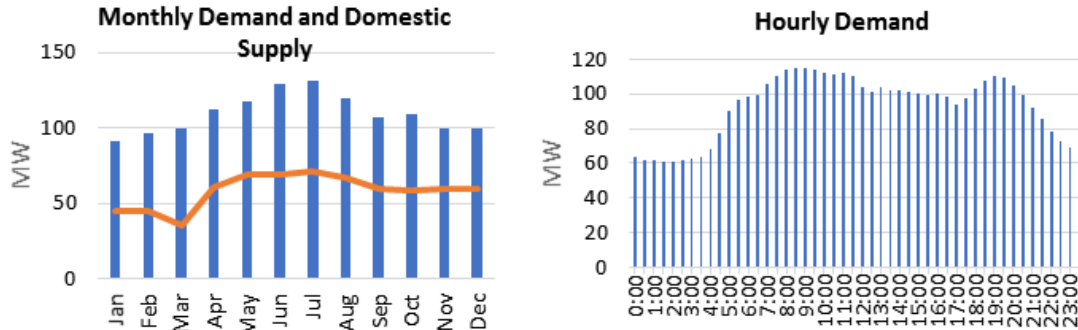

Note: The monthly peak demand is an average of 2010 to 2016 due to outliers in the data.

Source: LEC.

In 2016, peak demand was 153 MW, more than double the installed capacity of MHP. By 2020, Lesotho’s electricity demand is expected to reach 304 MW and by 2035, 432 MW.<sup>49</sup> Demand will be driven by electrification efforts, developments such as the Letseng diamond mine, and load growth over time. Additional capacity investments will be needed to meet the electricity supply gap. Figure 3.10 shows the electricity load forecast for Lesotho from 2016 to 2035.

<sup>49</sup> Lesotho National Development Corporation, “Lesotho Energy Sector Profile,” 2017.

**Figure 3.10: Load Forecast, 2016-2035 (MW)**

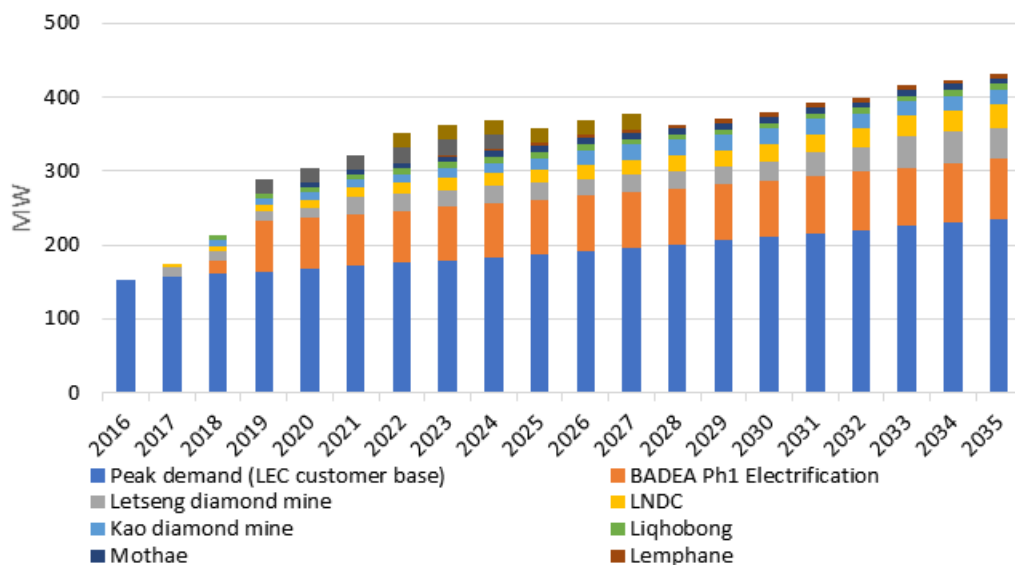

Source: Consultant’s estimates based on DoE data

Note: Peak demand is assumed to increase by 2.3 percent each year. Letseng diamond mine is assumed to begin operations in 2017. LEC customer base includes domestic, commercial, and industrial customers.

### 3.4 Key Challenges in the Energy Sector

The key challenges facing Lesotho’s energy sector are low energy access, energy security, and declining biomass stocks.

#### 3.4.1 Energy access

One of the primary challenges in Lesotho’s energy sector is the low rate of household access to electricity and modern, cleaner sources of energy for lighting, heating, and cooking.<sup>50</sup> Access to affordable, modern energy sources reduces poverty, enables economic growth, improves health, and increases productivity.<sup>51</sup> Nationwide, only about 38 percent of households have access to electricity. Electricity access rates are 60 percent for urban and peri-urban households and 18 percent for rural households. Electrification is challenging because of the costs of extending grids to mountainous areas and to populations spread out in small clusters. In 2017, the GoL set an electrification target to bring electricity to 75 percent of households by 2020.

Absent electricity access, many households rely on gas, paraffin, wood, coal, or dung as sources of energy for lighting, heating, and cooking. Burning these fuels in the home can lead to negative health outcomes. Gathering these fuels can also be time-consuming for households; according to African Clean Energy’s 2015 survey of 2,652 rural households in Lesotho, households spent 31 hours per month travelling for fuel,

<sup>50</sup> The UN Secretary-General’s Advisory Group on Energy and Climate Change (AGECC) defines modern energy sources as fuels such as natural gas, liquid petroleum gas (LPG), diesel and biofuels such as biodiesel and bioethanol; or technology, such as improved cooking stoves, that can enable cleaner and more efficient delivery of traditional fuels. AGECC, “Energy for a Sustainable Future,” April 2010.

<sup>51</sup> International Energy Agency, World Energy Outlook, “WEO – Modern Energy for All: Why it Matters,” accessed February 16, 2017, available: <http://www.worldenergyoutlook.org/resources/energydevelopment/modernenergyforallwhyitmatters/>.



covering an average distance of 58 km.<sup>52</sup> The GoL wants to promote the safe, efficient use of cleaner fuels that will reduce health problems and ensure the sustainability of biofuel stocks. However, access to alternative technologies is limited by cost, availability, and lack of private sector suppliers.

### **3.4.2 Energy security**

As described in Sections 3.2 and 3.3, energy demand in Lesotho outstrips available domestic supply, leaving the country reliant on expensive electricity imports. Peak demand in 2016 was about 153 MW, but is expected to grow to 304 MW by 2020 and 432 MW by 2030. Lesotho's only functional hydropower plant, Muela, has a capacity of just 72 MW. LEC forecasts that it will import over 282 GWh of electricity from South Africa (Eskom) and Mozambique (EDM) in 2016-2017 at prices ranging from M 0.77 to 1.50 per kWh, while purchases from Muela are just M 0.13 per kWh. In 2015, electricity imports accounted for 66 percent of LEC's supply costs. The persistence of expensive fuel imports that are denominated in Rand or US dollars also has a toll on Lesotho's monetary policy. The long-term impact of purchasing Rand (also to maintain the currency peg) and US dollars would cause the Maloti to depreciate, increasing the cost of all imported goods and services into Lesotho.

The energy supply gap is not limited to electricity. Lesotho imports all its petroleum (16 percent of primary energy demand) needs from South Africa and only has a maximum of three days of fuel reserves in country at any time. In 2012, petroleum imports made up six percent of GDP. The GoL wants to reduce this dependence on electricity imports and increase energy security by exploiting Lesotho's vast, untapped RE potential. The GoL hopes developing RE may also allow the country to export electricity to its neighbours.

### **3.4.3 Rapidly declining biomass stock**

Lesotho has very low rates of forest cover (about 1.6 percent in 2012), made worse by the unsustainable use of wood for fuel, and leading to potentially severe environmental and social consequences.<sup>53</sup> With the demand for wood outpacing its supply, households often turn to substitutes. Use of other biomass sources, like crop waste and dung, deprive agricultural land of manure, contributing to a loss of soil fertility.<sup>54</sup> Other fuel sources, such as paraffin and LPG, are considerably more expensive, putting a strain on household budgets. Continuing to rely on wood as a fuel source means spending more time and travelling greater distances to collect it, a burden that disproportionately falls on women. The GoL has set a target for increasing tree cover to five percent by 2020, and has called for financial support to subsidize fuel-efficient cook stoves and alternative fuels and techniques for cooking.

---

<sup>52</sup> African Clean Energy, "Summary Statistics Overall," accessed February 15, 2017, available <<https://share.geckoboard.com/dashboards/3AB67CC423C6D402>>, 2015.

<sup>53</sup> Ministry of Energy and Meteorology, "Lesotho's Intended Nationally Determined Contributions," 2015.

<sup>54</sup> B.M. Taele, K.K. Gopinathan, and L. Mokhuts'oane, "The Potential of Renewable Energy Technologies for Rural Development in Lesotho," *Renewable Energy* 32 (2007), 609-622.

## 4 Overview of the Renewable Energy Sector

The GoL has set targets to increase RE generation by 200 MW by 2020 as part of efforts to mitigate the effects of climate change and solve Lesotho’s energy sector challenges. In its Energy Policy, the GoL has committed to improving access to RE specifically to increase Lesotho’s energy security and Basotho access to modern energy sources, and reduce the carbon intensity of the energy sector.

As described in section 3.2, Lesotho relies heavily on imports from South Africa – 93 percent of which is produced from coal – to meet its electricity demand needs<sup>55</sup> and many rural Basotho still rely on inefficient sources of fuel to meet household energy needs. Investments in RE can help change these trends. A variety of options are available to Lesotho, including on-grid technologies such as utility-scale wind, solar, waste-to-energy, and small hydro; and off-grid technologies such as microgrids and distributed RE technologies.

An assessment of technical potential for various RE technologies that can be used in Lesotho was carried out to support the preparation of the IP. The results of the resource assessment are shown in Table 4.1.

**Table 4.1: Summary of RE Technical Potential**

Technology	Resource	Generation Capacity (MW) <sup>1</sup>	Annual Generation (GWh)
Utility-Scale Solar PV <sup>56</sup>	Solar	118*	372
Utility-Scale Wind	Wind	2077*	5,157
Small-Scale Hydro (<10 MW)	Water	36	193
Waste-to-Energy	City Waste	10	62
Solar Microgrids	Solar Battery	31*	85
Floating Micro-Hydro Microgrids	Water	0.50	1.75
Solar Home Systems	Solar Battery	1.2	3
Micro-Solar Technologies <sup>2</sup>	Solar	38*	92
<b>Total</b>		<b>2,311.70</b>	<b>5,965.75</b>

Note: \*Estimates for all solar PV (case 2), all wind (case 2), all solar microgrids, and all SHS that is possible in non-excluded areas. For other technologies, it only includes the proposed plants.<sup>1</sup>

<sup>55</sup> World Bank, “World Development Indicators: Electricity Production from Coal Sources”, 2014.

<sup>56</sup> PV refers to photovoltaic

Only includes known estimated potential of solar street lights, solar water pumps and solar irrigation.

A national resource assessment with consistent data gathering techniques, analysis assumptions and methodologies has not been conducted in Lesotho. Therefore, the technical assessment was based on a variety of sources – each described in the following technology sub-sections – that are used by RE researchers and developers worldwide. The datasets used were also cross-referenced against comparable regional RE developments and isolated studies on resource potential.

<sup>1</sup> Excludes battery storage component of some technologies. <sup>2</sup> Additional information is needed to determine more specifically, the technical potential of micro-solar technologies.

---

The technical potential for RE in Lesotho is high, but its development and deployment is slow because of several barriers including: an unestablished enabling environment, limited financing and delivery options, insufficient experience of GoL in managing and implementing RE projects, and general lack of awareness among the Basotho of the availability and benefits of RE technologies.

The sub-sections below provide an overview of the RE sector in Lesotho. Sections 4.1 and 4.2 describe the current use of and potential of various RE technologies in Lesotho. Section 4.3 describes the availability of financing for RE projects in Lesotho, and section 4.4 summarizes barriers to scaling-up RE and proposes measures to overcome them.

## **4.1 Potential for On-Grid Renewable Energy Technologies**

As described in Section 3.2, Lesotho does not have sufficient domestic generation capacity to meet peak demand and relies on imports to bridge the supply gap. The electricity supply gap is likely to increase as Government electrifies the population and exploits new diamond mines, further weakening Lesotho's security of supply. Based on discussions with stakeholders, existing reports, and data, utility-scale solar photovoltaic (PV), utility-scale wind farms, SHPP, and waste-to-energy plants were selected as potential on-grid RE technologies for elaboration in this IP to help the GoL reach its goal of meeting base load demand needs. The sub-sections below provide an overview of existing use and technical potential of each technology.

### **4.1.1 Utility-scale solar photovoltaic (PV)**

Utility-scale solar currently makes up a small proportion of Lesotho's generation capacity, but there is substantial potential because Lesotho receives more than 300 days of sun each year. There are two operational small utility-scale solar park projects, both in Maseru district, with a total installed capacity of just 0.035 MW. A 281 kW small solar installation at the Moshoeshoe I International Airport is used primarily to serve the airport's electricity demand during the day. The system does not have storage capability and excess power generated flows back to the national grid. A 2.4 kW small solar installation is in Roma at the National University of Lesotho and is used largely for research and educational purposes.

There has been substantial interest from the private sector and the GoL in developing larger scale solar parks in recent years; six larger solar park projects have been proposed by the GoL and private developers, with a total installed capacity of 50 MW.

Table 1.2 below summarizes the existing and proposed utility-scale solar PV projects in Lesotho.

**Table 4.2: Existing and Proposed Utility-Scale Solar PV Projects**

Project Name	District	Resource	Project Status	Capacity (MW)
Moshoeshoe I	Maseru	Small Solar	Operational	0.281
Roma	Maseru	Small Solar	Operational	0.024
Maseru	Maseru	Solar Park	Proposed	20
Hlotse – 1	Leribe	Solar Park	Proposed	2
Mafeteng – 1	Mafetang	Solar Park	Proposed	2
Maputsoe	Leribe	Solar Park	Proposed	1
Mohales Hoek - 1	Mohale’s Hoek	Solar Park	Proposed	5
Neo 1	Mafetang	Solar Park	Proposed	20
<b>Total</b>				<b>50.305</b>

Sources:

- 1) Lesotho Power Generation Master Plan, Lesotho Electric Company – SSI, 2010
- 2) Lesotho’s first utility-scale solar PV Power Plant Proposal, OnePower
- 3) “Yield and performance analysis of the first grid-connected solar farm at Moshoeshoe I International Airport, Lesotho”, Renewable Energy Journal

The potential for solar energy depends on the intensity and duration of exposure to sunlight at a given location. Data on solar insolation were from the VAISALA/IRENA 3km Global Solar Dataset.<sup>57</sup> The technical potential of solar parks was determined by first evaluating the overall resource potential, in terms of solar insolation, and then applying exclusions to limit this potential only to areas practical for development. Areas that were excluded included forests, wetlands, urban areas, locations farther than 20 km from the nearest transmission line, protected areas (existing and proposed National Parks and Forests), and Freshwater Ecological Protected Areas (FEPAs).

The final exclusion criterion was land slope: two cases were developed to show resource potential after the other exclusion criteria were applied. In Case 1, all land with a slope greater than 10 percent was excluded. In the more restrictive Case 2, all land with a slope greater than 5 percent was excluded. Figure 4.1 shows the results of the resource assessment after applying the exclusion criteria. Table 4.3 shows the results of the resource assessment by district under the more restrictive Case 2.

<sup>57</sup> The VAISALA 3Tier v1.2 dataset has Typical Meteorological Year (TMY) data for Lesotho, developed based on the historical time series dataset available at a 3 km spatial resolution from 1998 to the present (19 years); TMY thus provides a better representation than using a single historical year. The dataset is validated against multiple ground stations globally. The uncertainty of the dataset is five percent.

**Figure 4.1: Solar Park Resource Maps**

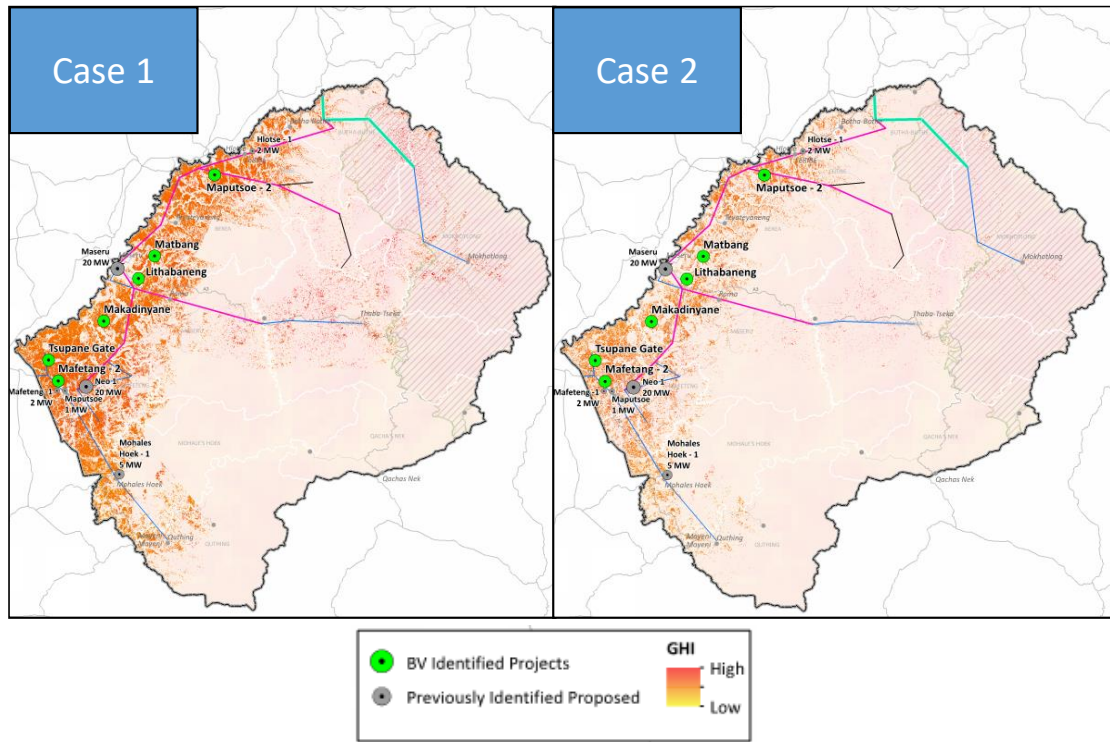

**Table 4.3: Solar Parks Technical Potential by District, Case 2**

District	Land (km <sup>2</sup> )	Capacity (MW)	Capacity Factor (%)	Annual Generation (GWh)
Berea	111	16	35.3%	49
Leribe	145	21	35.0%	64
Maseru	157	22	34.7%	67
Mokhotlong	17	2	36.3%	6
Quthing	17	2	35.2%	6
Butha-Buthe	23	3	35.2%	9
Mafeteng	248	35	35.1%	108
Mohale's Hoek	100	14	34.8%	43
Thaba-Tseka	18	3	36.0%	9
<b>Total</b>	<b>836</b>	<b>118</b>		<b>362</b>

Note: A conservative estimate of technical potential for solar park development (50 percent of available land post exclusions) is shown here to take into account Lesotho's agricultural land use needs.

The technical resource assessment also identified six potential project sites (highlighted in green markers) for utility-scale solar PV project development in Lesotho. These sites met the exclusion criteria: areas with high levels of solar insolation and in proximity to the transmission network. Capacity factors were

calculated for these locations based on standard system design parameters and solar resource data obtained for these locations. Table 4.4 lists the potential projects, their locations, proposed capacity, and estimated annual electricity production.

**Table 4.4: Technical Potential of Proposed Solar Park Projects**

Proposed Project	District	Proposed Capacity (MW)	Estimated Capacity Factor (%)	Annual Production (GWh)
Tsupane Gate	Mafeteng	10	35.0	30.7
Mafetang – 2	Mafeteng	10	35.6	31.2
Makhalinyane	Maseru	15	34.8	45.7
Lithabaneng	Maseru	10	34.7	30.4
Matbang	Berea	10	35.8	31.4
Maputsoe – 2	Leribe	10	35.0	30.7
<b>Total</b>		<b>65</b>		<b>200.0</b>

#### 4.1.2 Utility-scale wind power

There are currently no wind farms operating in Lesotho but attempts have been made by various developers to undertake wind measurements and conduct feasibility studies at potential sites in Letseng, Semonkong, and Oxbow. The development that has made the most progress is the 35 MW (42 x 850 kW) Letseng windfarm project. The project, which was initially stalled over concerns of endangered Cape and Beard Vulture species is now awaiting a power purchase agreement, land acquisition rights, and equity investors. Table 4.5 summarizes the planned and proposed wind power projects in Lesotho.

**Table 4.5: Planned and Proposed Utility-Scale Wind Power Projects**

Project Name	Administrative Division	Resource	Project Status	Capacity (MW)
Wind Park at Letseng*	Mokhotlong	Wind	Planned	35.7
Wind Park at Semonkong*	Maseru	Wind	Proposed	15.0
Wind Park at Oxbow**	Butha-Buthe	Wind	Proposed	TBD

\* Source: Lesotho National Development Corporation

\*\*Source: Wind farms Threaten Southern Africa’s Cliff Nesting Vultures

The technical potential of wind energy depends on wind speeds at certain altitudes above ground level. Data on wind speeds were from the University of Denmark (DTU) Global Wind Atlas, measuring mean wind speeds at heights of 50, 100 and 200 meters above ground level. A set of geographical exclusions were applied to limit the technical

potential of wind energy to areas of practical and environmentally sound development. There are substantial environmental risks associated with wind farms such as the impact on local bird and bat populations. Design and deployment should avoid the ridgetops of Lesotho. Exclusion areas included places that were further than 20 km from the nearest transmission line, wetlands, forests, National Forests, and FEPAs.

Land slope was the final exclusion. It is possible to construct wind farms on slopes between 8 and 15 percent, but there are additional challenges such as foundation instability and difficulty delivering equipment. Two cases were developed to evaluate the wind potential at two different slope levels: Case 1 excluded slopes greater than 15 percent and the more restrictive Case 2 excluded slopes greater than 8 percent. Figure 4.2: displays the results of the resource assessment with applied exclusions. For both cases the potential areas are concentrated towards the west of the country, in the lowlands. These areas are close to urban centres, facilitating transmission.

**Figure 4.2: Wind Resource Maps**

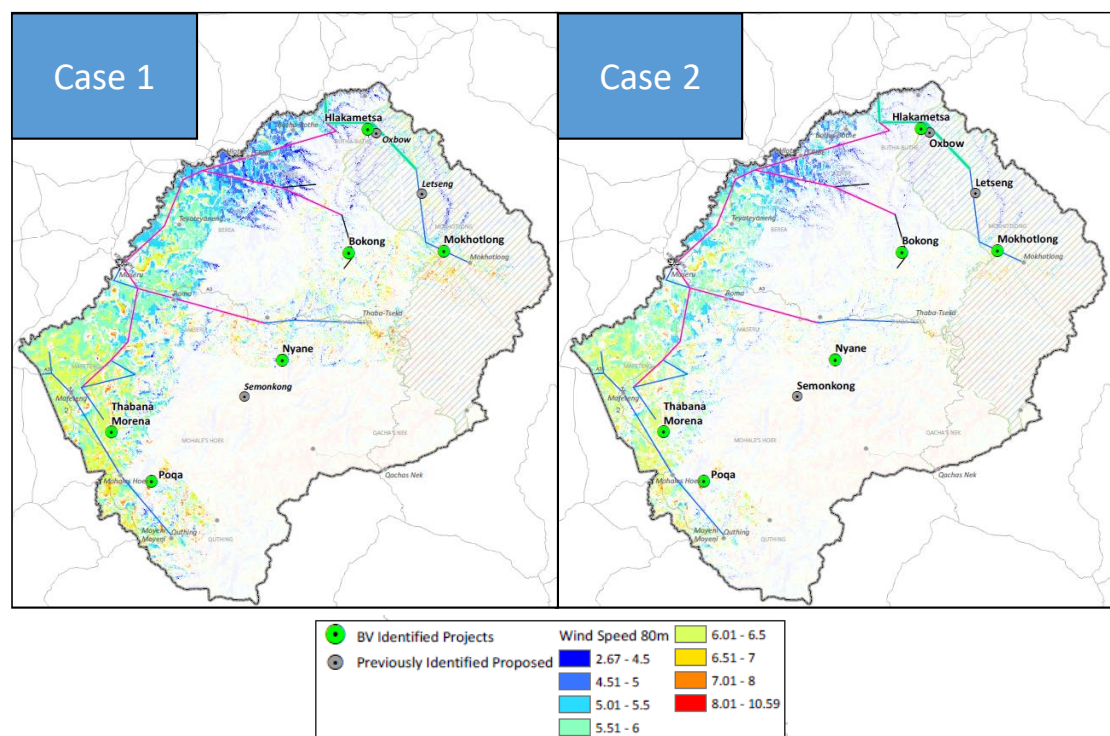



Table 4.6 shows the buildable capacity of wind farms by capacity factor. Most of the buildable wind capacity—82 percent—has capacity factors that range between 25-30 percent.

**Table 4.6: Buildable Capacity of Wind Farms by Capacity Factor**

Capacity Factor Range	Area (Sq. Km)	MW	Average Net Capacity Factor	Buildable MW*	Percentage of Buildable capacity
25% – 27.5%	718	1795	26.3%	898	43%
27.5% – 30%	638	1594	28.6%	797	38%
30% – 35%	259	648	31.6%	324	16%
35% - 45%	46	115	36.9%	58	3%
<b>Total</b>	<b>1,661</b>	<b>4,152</b>	<b>28.3%</b>	<b>2,077</b>	<b>100%</b>

Note: \*Buildable MW assumes 50% of available land coverage

The technical evaluation further identified six potential sites for wind projects. These projects met the more stringent Case 2 criteria (8 percent slope) and are listed below in Table 4.7: Feasibility studies need to be conducted to determine the buildable capacity for each site.

**Table 4.7: Potential Wind Farm Projects**

Name	District	Capacity Factor (%)
Bokong	Thaba-Tseka	37.9
Hlakametsa	Butha-Buthe	34.0
Mokhotlong	Mokhotlong	39.1
Nyane	Thaba-Tseka	38.6
Poqa	Mohale’s Hoek	40.5
Thabana Morena	Mafeteng	39.5

Note: Capacity factors were calculated using mean wind speeds from the DTU Global Wind Atlas and from power curves for the IEC class turbine. A 20 percent reduction from gross production was assumed (amount accounts for losses from turbine availability, utility downtime, electrical efficiency, blade degradation, extreme weather, power curve performance and wake loss.) Actual losses will vary by location.

#### 4.1.3 Small hydropower (<10 MW)<sup>58</sup>

There is substantial potential for small hydropower development in Lesotho; the estimated generation capacity from unexploited hydro resources is about 361 MW.<sup>59</sup> Technical assessments for small hydro were conducted as part of the Power Generation Master Plan in 2009. The Master Plan proposes 11 SHPP with a total

<sup>58</sup> Potential sites only included generation under 10 MW of capacity because large-scale hydropower projects are currently being considered under phase II of the LHWP.

<sup>59</sup> SSI: a DHV Company, “Lesotho Power Generation Master Plan: Final Milestones Report” Volume 1, Part 1.1: Hydro Power Generation Option, Project LEC/GEN/1-2009. (2009)

combined capacity of nearly 88 MW.<sup>60</sup> Table 4.8 provides a summary of the proposed hydropower sites.

**Table 4.8: Potential Small Hydropower Plant Sites Proposed in the Hydrogeneration Master Plan**

Site	Name of the River	Potential Capacity (MW)	Expected Annual Generation (GWh)
Hlotse HPP <sup>61</sup>	Hlotse	6.5	39.7
Phuthiatsana HPP	Phuthiatsana	5.4	18.87
Khubelu HPP	Khubelu	14.6	64.26
Polihalie HPP	Mokhotlong	19.3	83.89
Tsoelike HPP	Tsoelike	17.7	69.86
Makhaleng 1 HPP	Makhaleng	2	15
Makhaleng 2 HPP	Makhaleng	1.4	6.15
Makhaleng 3 HPP	Makhaleng	8.9	39.4
Makhaleng 4 HPP	Makhaleng	9.1	58.3
Quthing 1 HPP	Quthing	0.63	2.31
Quthing 2 HPP	Quthing	2.4	9.61
<b>Total</b>		<b>87.93</b>	<b>407.35</b>

Source: SSI: a DHV Company, "Lesotho Power Generation Master Plan: Final Milestones Report" Volume 1, Part 1.1: Hydro Power Generation Option, Project LEC/GEN/1-2009. (2009)

The technical potential of each proposed site was re-evaluated for the IP. In addition, non-operational SHPPs (described in Section 3.2) were also included in the analysis because they can be rehabilitated. The exclusion criteria for the technical analysis included urban areas; proximity to wetlands, protected areas, and FEPA areas; and areas within 20 km of the nearest transmission line. Potential sites that are greater than 10 MW were also excluded because medium and large hydropower projects are currently being considered under phase II of the LHWP. Figure 4.3 displays the results of the technical assessment after the exclusions were applied. Four of the original 11 sites proposed in the Master Plan and two existing but non-operational SHPPs, Tsoelike and Tlokoeng met eligibility criteria. In addition, the analysis revealed one previously unidentified site.

<sup>60</sup> SSI: a DHV Company, "Lesotho Power Generation Master Plan: Final Milestones Report" Volume 1, Part 1.1: Hydro Power Generation Option, Project LEC/GEN/1-2009. Table 1. (2009) [ibid.]

Table 1 of the report in fact lists 12 hydropower plants, but the Quthing-3 Pumped Storage Plant was omitted from consideration since its potential capacity was rates at 1.8GW and so does not count as a small hydropower plant.

<sup>61</sup> HPP refers to hydropower plant

**Figure 4.3: Proposed Small Hydropower Plant Locations**

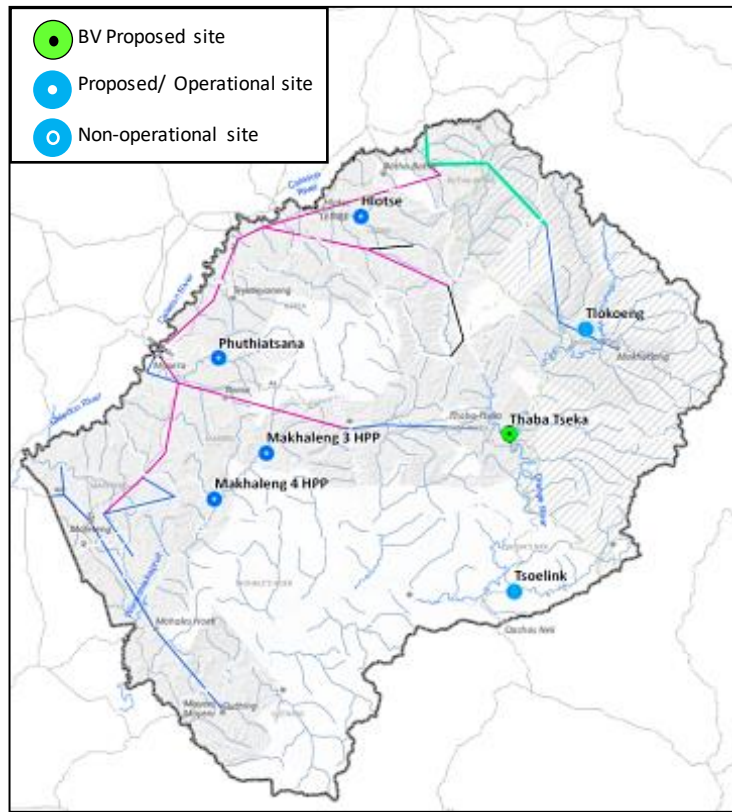

The total capacity of the technically feasible sites is 69.8 MW. Table 4.9: summarizes each site's installed capacity, annual generation, and estimated capacity factors.

**Table 4.9: Summary of Potential Small Hydropower Sites**

District	River	Name	Type	Installed Capacity (MW)	Capacity Factor (%)	Annual Generation (GWh)
Leribe	Hlotse	Hlotse	R	6.5	70	39.7
Maseru	Phuthiatsana	Phuthiatsana	R	5.4	40	18.9
Maseru	Makhaleng	Makhaleng-3	ROR	8.9	51	39.4
Maseru	Makhaleng	Makhaleng-4	R	9.1	73	58.3
Thaba-Tseka	Malibamat'so	Thaba-Tseka	R	4.5	76	30.0
Qacha's Nek	Senqu	Tsoelike*	ROR	0.40	103	3.61
<b>Total</b>				<b>34.8</b>		<b>189.91</b>

Note: R = reservoir and ROR = run-of-river

Data in the Power Generation Master Plan did not include specific data that shows monthly or quarterly water flows; as such generation capacity and generation of proposed plans are only indicative.

Source: SSI: a DHV Company, "Lesotho Power Generation Master Plan: Final Milestones Report" Volume 1, Part 1.1: Hydro Power Generation Option, Project LEC/GEN/1-2009. (2009) and Black and Veatch.

#### 4.1.4 Bioenergy

There are currently no existing utility-scale biomass or biogas power generation facilities in Lesotho, but there is some interest among Government and private sector stakeholders in developing future projects to reap the benefits of improved urban waste management, increased power generation capacity, and domestic fuel (liquid and gas) production. Waste-to-energy plants also have very high capacity factors (70-95 percent) and can be dispatched, a benefit for a net importer that relies on non-dispatched hydro generation like Lesotho.

Projects have not been realized for several reasons. As described in Section 3.4.3, biomass stock in Lesotho has steadily been declining since 1999. There is no central waste collection or segregation—about 50 percent of waste generated in is not segregated and seeps into waterways—and more importantly, the mass collection of biomass for electricity production is often difficult and cost prohibitive. However, a private developer from the United Kingdom has conducted a feasibility study to determine the viability of developing waste-to-energy facilities in urban areas. The proposed waste-to-energy facilities would produce refuse derived fuel by breaking down waste into medium calorific gas or "syngas" in a fluidized bed gasifier. The syngas, which is ideal for producing electrical energy, is then combusted in an internal combustion engine to produce electricity. Figure 4.4 illustrates the production cycle.

**Figure 4.4: Production Cycle for Proposed Waste-to-Energy Facilities**



Source: Prime Enviro Energy, “Waste-to-Energy in the Kingdom of Lesotho: Project Outline/Executive Summary”, 2013.

The feasibility study excluded areas that were close to 33 kV distribution lines and settlement areas with a population of less than 100,000 and no sizable industrial waste, narrowing down potential areas for waste-to-energy facility development to urban centres in four districts: Maseru, Leribe (only includes Hlotse, Mapotsoe, and rural areas), Butha-Buthe, and Mafeteng

The study assessed the resource potential for bioenergy in the four districts by analysing each district’s waste characteristics and determining the potential fuel and syngas that can be derived from the waste segregation. Waste characteristics of Maseru City were extrapolated from a baseline assessment for waste management in Maseru City conducted by the United Nations Environment Programme (UNEP).<sup>62,63</sup> For urban areas in other districts the quantity and characterisation of waste was determined by adjusting data from the UNEP study to local economic and demographic conditions, conducting site visits, interviewing stakeholders, and analysing dumpsite waste samples. Table 4.10 shows the results of the resource potential.

**Table 4.10: Summary of Waste Resource Potential in Four Districts**

Districts	Dry Waste Potential (ton/ year)	Waste energetic Potential (kWt)	Energy Potential (kW) <sup>1</sup>
-----------	---------------------------------	---------------------------------	------------------------------------

<sup>62</sup> UNEP, “Baseline Assessment of Waste Management in Maseru City”, 2006.

<sup>63</sup> The baseline assessment used a quantitative and consultative approach, which included detailed questionnaires for residential, commercial, administrative, and industrial, segments of the population on the volume and characteristic of waste produced; and field measurements of the weight of waste produced to verify survey data; and interviews with various government stakeholders, drivers of cleaning vehicles, and street cleaners.

Maseru	70,916	35,992	9,988
Butha-Buthe	9,368	7,290	1,786
Leribe	7,480	5,542	1,358
Mafeteng	19,135	14,589	3,574
<b>Total</b>	<b>106,899</b>	<b>64,413</b>	<b>9,216</b>

Note: <sup>1</sup>Includes electricity, liquid and gaseous fuels that will be produced.

Source: Prime Enviro Energy, "Waste-to-Energy in the Kingdom of Lesotho: Project Outline/Executive Summary", 2013.

The logistics of collection and separation of waste will determine whether the resources can be tapped for electricity generation. While these four districts show the potential to have sufficient waste resources for generation, the technical viability of some of the sites is still unclear. Developing efficient and reliable waste collection may be more difficult to achieve outside of the less densely populated areas outside of Maseru. Additional and up-to-date analysis of waste production and the logistics of waste collection and segregation should be conducted to further validate the technical potential for waste-to-energy facilities in Butha-Buthe, Leribe, and Mafeteng. However, given the population density and potential to more efficiently collect waste in Maseru the 9.98MW waste-to-energy facility in Maseru City is considered technically viable.

## 4.2 Potential for Off-Grid Renewable Energy Technologies

As described in Section 2, 73 percent of the population in Lesotho lives in rural areas, of which 22.9 percent have access to electricity. Most rural households rely on lower quality fuels for their energy needs such as biomass for heating and cooking, and paraffin for lighting. In addition, Lesotho's challenging topography means that grid extension is costly and often unfeasible. Off-grid RE solutions provide solutions to the rural population's energy needs. The sub-sections below discuss existing penetration and technical potential off-grid RE technologies. Section 4.2.1 describes microgrid solutions, section 4.2.2 describes SHS, and section 4.2.3 describes distributed RE technology solutions.

### 4.2.1 Microgrids<sup>64</sup>

Government and non-governmental organizations (NGO) have implemented several microgrid projects in Lesotho. The GoL implemented two microgrids – one micro diesel and one micro-hydro – pilots as part of the World Bank Utilities Sector Reform Project (2007)-

The use of microgrids is likely to increase in the coming years. The United Nations Development Programme (UNDP) and European Delegation (EU) have recently allocated funding for microgrid pilots in rural villages around the country. The UNDP will conduct pre-feasibility studies in 20 pre-identified villages to determine the

<sup>64</sup> The terms micro- and mini-grid are sometimes used interchangeably and other times used to refer to the varying sizes in isolated systems. For this IP, we use the term microgrid to refer to an isolated grid with less than 10 kW system capacity.

appropriate microgrid technology for implementation. The EU will call for proposals to pilot two microgrid projects in rural areas with substantial economic growth potential. There is also some private sector interest in developing small hybrid PV microgrids to serve rural populations outside of the LEC service areas. Microgrids are often considered in areas where grid extension is not viable or cost prohibitive. They are also used to strengthen centralized grid systems because they operate autonomously.

### **Small PV microgrid**

There are currently no solar PV microgrids in Lesotho, but there is substantial private sector and development partner interest in developing them.

Solar PV microgrids, depending on their size and the types of populations they serve, are considered viable in areas that are of a certain population density. The technical potential for 5 kW (type A) and 8 kW (type B) microgrids were assessed. The type A microgrid is viable when 15 households (with an average of four members) live within one square kilometer of each other. Type B microgrids are viable when 25 households (100 persons) live within one square kilometer of each other.<sup>65</sup> Areas with sufficient population density were derived from GIS data provided by the Centre for International Earth Science Information Network. It was assumed that areas with more than 60 persons living in one square kilometer could be served by a type A microgrid while areas with more than 100 persons in a square kilometer were assumed to be served by a type B microgrid. In addition, several of the same exclusion criteria used to estimate the potential for other RE technologies were applied. They include areas close to wetlands, protected areas, FEPA areas; and districts outside of the highlands. Table 4.11 shows the technical potential for solar PV microgrids by district.

---

<sup>65</sup> Population density thresholds were determined based on OnePower and B&V experience. Two microgrid types presented cover a range of economic activity.

**Table 4.11: Technical Potential for Microgrids**

District	Microgrid type	Number of Microgrids	PV capacity (kW)	Battery energy (kWh)
Mohale's Hoek	Type A <sup>1</sup>	1,546	7,730	29,374
	Type B <sup>2</sup>	387	3,096	12,384
Mokhotlong	Type A	14	70	266
	Type B	-	0	0
Qacha's Nek	Type A	588	2940	11,172
	Type B	-	0	0
Quthing	Type A	1,236	6,180	23,484
	Type B	376	3,008	12,032
Thaba-Tseka	Type A	1,530	7,650	29,070
	Type B	-	0	0
<b>TOTAL</b>	<b>Type A</b>	<b>4,914</b>	<b>24,570</b>	<b>93,366</b>
	<b>Type B</b>	<b>763</b>	<b>6,104</b>	<b>24,416</b>

Note: <sup>1</sup>Type A microgrids are sized to serve 15 households (60 persons), with an annual load of 14MWh. A PV size of 5kW and battery size of 19kWh is assumed. <sup>2</sup>Type B microgrids are sized to serve 25 households (100 persons) with an annual load of 23 MWh. A PV size of 8kW and batter size of 32kWh is assumed. An average 2.5kWh/day load per household is assumed.

A private developer has identified 25 specific sites for solar PV hybrid microgrids ranging in size from 8-109 kW that will provide continuous service to rural communities. The developer is currently working with the GoL and UNDP to introduce pilot microgrids at some of the sites.

#### **Floating micro-hydro**

A floating micro-hydro system is an alternative to solar microgrids. An advantage of floating micro-hydro systems is ease of deployment. The system involves a blade turbine mounted on a prefabricated platform or pontoon that floats in the middle of a river that only requires a minimum current velocity of 2 m/s and a minimum water depth of 1 m for operation. When two units are on one platform, there must be at least 0.5 m space between units (measured from blade to blade). These systems are approximately 100 kW in size, but several can be strung together. They are best located near communities or where there is load. To date, there are no off-grid micro-hydro systems in Lesotho. Figure 4.5 displays deployed floating micro-hydro systems.



**Figure 4.5: Floating Micro-Hydro Systems**



Source: B&V

The resource assessment for floating micro-hydro was based on the Lesotho Hydro Master Plan’s historical river flow estimates. Exclusion criteria (like those of solar microgrids) were applied to determine practical areas for deployment of floating micro-hydro; excluded areas include wetlands, protected areas (existing and proposed National Forests), and FEPAs. Locations should also be close to small and medium-sized settlements where the energy generated could be consumed. Figure 4.6 below shows the locations of five proposed floating micro-hydro projects. Table 4.12 summarizes the technical potential at these sites.

**Figure 4.6: Proposed Locations for Floating Micro-Hydro Projects**

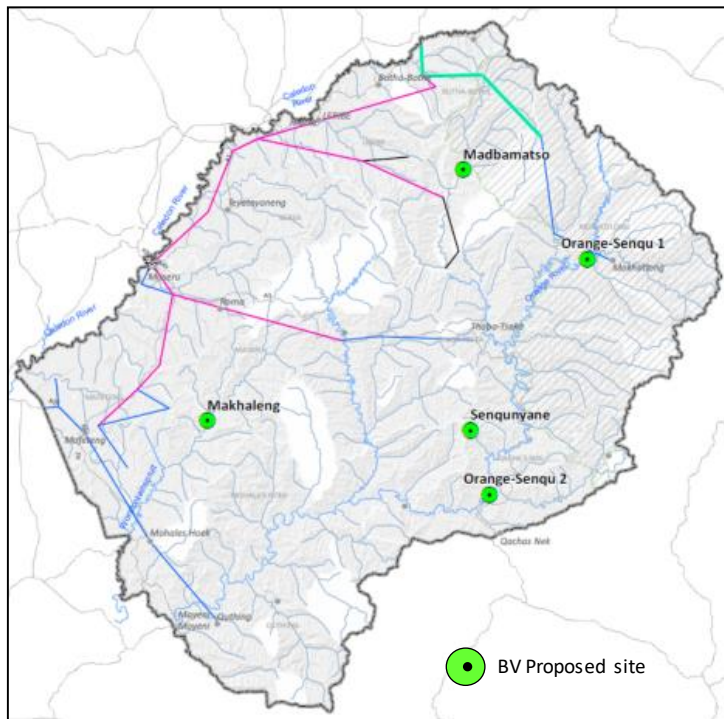

**Table 4.12: Technical Potential of Proposed Floating Micro-Hydro Projects**

Site	River	Capacity (MW)	Annual Generation (GWh)
------	-------	---------------	-------------------------

Malibamatso	Malibamatso	0.1	0.35
Makhaleng	Makhaleng	0.1	0.35
Senqu 1	Senqu	0.1	0.35
Senqu 2	Sengu	0.1	0.35
Senqunyane	Senqunyane	0.1	0.35
<b>Total</b>		<b>0.5</b>	<b>1.75</b>

#### 4.2.2 Solar home systems

A SHS is an off-grid system consisting of a combined solar panel and battery unit that provides a small amount of electricity that can power basic appliances such as lights, radios, and fans; it can be an electrification option for households living in areas where a microgrid is not viable. About one percent of rural households in Lesotho currently use SHS, with a total installed capacity of 61.6 kW.

The GoL has some experience introducing SHS to the Basotho.

The GoL with assistance from the UNDP and GEF, began in 2007 to promote the use of RE for basic household energy requirements like lighting, radios, and cellphone charging through the Lesotho Renewable Energy-Base Rural Electrification Project (LREBRE). The project installed 1,537 SHS in Mokhotlong, Thaba-Tseka, and Qacha's Nek Districts over five years. Each SHS installation had a 70 or 75 W PV system with a 300 W DC/AC inverter. The terminal evaluation of the program noted that quality control of installations was low. At the time of the evaluation in 2013, it was estimated that half of the systems installed are no longer functioning or are providing low quality service because of a project design change, which did not take into account increased current from switching from alternating current lights to direct current lights that quickly degraded existing electrical wires. During the preparation of the IP, the DoE reported that none of the systems are still functioning because batteries have not been replaced.

The technical potential for further SHS deployment was determined using the same method used for solar microgrids. SHS deployment was assumed for areas with less than 40 people (10 households) living in one square kilometer. Population density was derived from GIS data provided by the Centre for International Earth Science Information Network. In addition, several of the same exclusion criteria used to estimate the potential for other RE technologies were applied. They include areas close to wetlands, protected areas, and FEPA areas. Finally, existing SHS deployed as part of the LREBRE program was subtracted from the gross technical potential to avoid double counting. Table 4.13 shows the technical potential for SHS in Lesotho.

**Table 4.13: Technical Potential for SHS**

Agro-ecological zone	District	No. of SHS systems	Total technical potential		Net Technical Potential (subtracting installed systems)		Generation (kWh)
			PV Capacity (kW)	Energy Stored (kWh)	PV Capacity (kW)	Energy Stored (kWh)	
Lowland	Berea	19	1.235	23	1.2	22.8	2,605
Lowland	Butha-Buthe	1,573	102.245	1,888	102.2	1,887.6	215,676
Lowland	Leribe	1,347	87.555	1,616	87.6	1,616.4	184,689
Lowland	Mafeteng	77	5.005	92	5.0	92.4	10,558
Lowland	Maseru	2,727	177.255	3,272	177.3	3,272.4	373,903
Highland	Mohale's Hoek	2,770	180.05	3,324	180.1	3324	379,799
Highland	Mokhotlong	5,483	356.395	6,580	726.4	13,410	1,532,221
Highland	Qacha's Nek	2,229	144.885	2,675			
Highland	Thaba-Tseka	5,000	325	6,000			
Highland	Quthing	2,395	155.675	2,874	155.7	2874	328,M&E2
	<b>Grand Total</b>	<b>23,620</b>	<b>1,535.3</b>	<b>28,344</b>	<b>1,177.8</b>	<b>26,499.6</b>	<b>3,027,834</b>

Note: 1,537 Systems installed in Mokhotlong, Thaba-Tseka and Qacha's Nek with UNDP/GEF-supported LREBRE Project. Data not available by district.

#### 4.2.3 Other distributed RE technologies

Microgrids and SHS are potential solutions for working towards universal access to electricity. For both technical and financial reasons, however, these technologies may not be realistic solutions for providing improved energy access to everyone. Other RE technologies could still be used to provide households and rural villages with the benefits of modern energy. The distributed RE technologies described below can replace or increase the efficiency of existing fossil fuel-based technologies. Others provide a service that would typically be delivered using a fossil fuel-based system. The sub-sections below describe several micro-solar technologies including SHSs, solar water pumps, solar water heating, solar irrigation, solar street lights; and clean cook stoves.

## Solar water pumps

Solar water pumps use solar PV to power pumps to deliver drinking water. Systems are often sized to supply small communities with a consistently accessible water source. The solar PV system is tied to an underground pump that draws water up from an identified underground source into a storage tank. The storage tank may then be tapped into, as needed, by community members seeking water. In Lesotho, solar water pumps are also used to provide reticulation from springs.

The Rural Water Supply Department in Lesotho is systematically retrofitting diesel pumps in all its service areas and making substantial progress. As of 2017, 80 percent of rural water supply systems identified under the program have been retrofitted. Solar arrays for the water pumps vary from 300 W to 1.5 kW, and can serve hydraulic load ranging from 300 to 1,100 m<sup>3</sup>/day. Discussions with the Rural Water Supply Department revealed that there were more supply systems that can be retrofitted but government funding for the program varies from year to year slowing the program's expansion. Figure 4.7 shows the progress of rural water supply solar water pump retrofits by district.

**Figure 4.7: Progress in Rural Water Supply Solar Water Pump Retrofits, 2017**

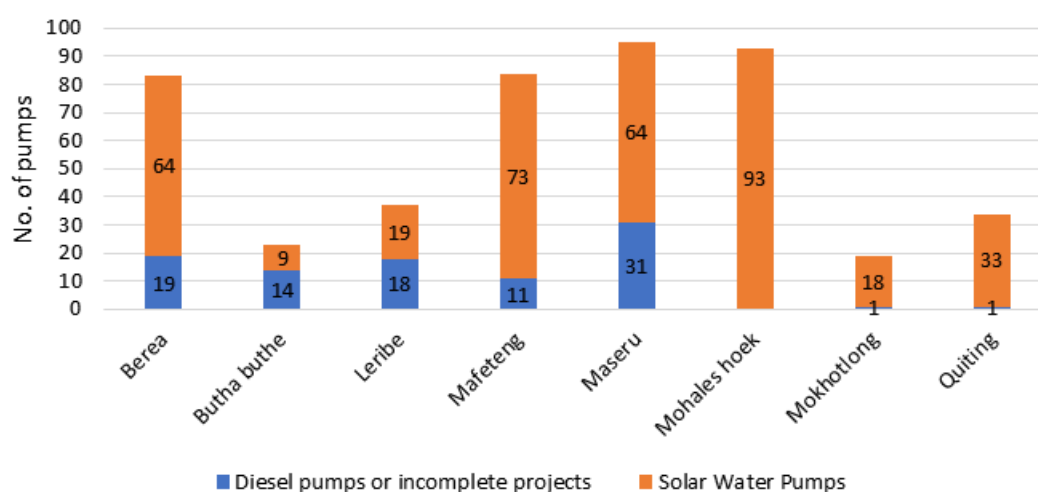

Source: Department of Rural Water Supply, Ministry of Water.

Solar water pumps can also support efforts to expand improved water access in the rural areas of Lesotho. In 2014, about 303 thousand of the rural population in Lesotho did not have access to an improved water source. Assuming an average pump capacity of two horsepower that is powered by 1.8kWp PV panels, and a basic needs demand for water of 30 liters person per day, about 148.99kW of pump capacity will generate 364.9MWh and result in universal access to improved water sources for all rural Basotho.<sup>66</sup>

<sup>66</sup> Number of pumps and capacity are rough estimates. Water depth and terrain will differ by site and impacting pump and PV panel specifications required for each system.

## Solar water heating

There are several methods to heat water using solar power, but all involve obtaining clean heated water using thermal energy converted from solar energy obtained from solar collectors. Collector fluid is heated by the solar collector and run through an exchanger which transfers heat between fluid sources. The incoming cold water supply is heated and the collector fluid returns to the solar collector for additional heating. Lesotho's Energy Policy 2015-2025 recommends replacing all electric geysers with solar water heaters in the commercial and residential sectors. It also requires that all new public buildings requiring hot water will need to install solar water heaters.

The Southern African Solar Thermal Training and Demonstration Initiative (SOLTRAIN) installed 200 solar thermal water heating systems throughout Southern Africa between 2009 and 2015, including ten systems in Lesotho. The Initiative has been extended for a second phase that includes a target of an additional 20 installations in Lesotho. Table 4.14 provides information on existing solar water heating projects in Lesotho.

**Table 4.14: Existing Solar Water Heating Projects in Lesotho**

Location	Year	Collector type	Collector Area (m <sup>2</sup> )	Collector Power (kW)	Water Storage Capacity (L)	Circulation
Mt. Moorosi BBCDC67 Training System 1	2014	Flat plate	7.05	4.9	500	Pumped
Mt. Moorosi BBCDC Training System 2	2014	Evacuated tube	3.70	2.5	200	Thermosyphon
Ha Ramabanta, Maseru: Nazareth Health Centre	2015	Flat plate	5.55	3.9	300	Pumped
Mohlakeng, Mohale's Hoek: St. Camillus Orphanage*	2014	Flat plate	9.92	6.9	800	Thermosyphon
Roma: St. Joseph Hospital	2015	Flat plate	14.1	9.8	1,000	Pumped

Note: \* Four systems were installed at this location.

Source: SOLTRAIN

## Solar irrigation

Solar irrigation uses electric pumps powered by solar technology to deliver water to croplands. As part of the LREBRE project, one solar PV water pumping project in

<sup>67</sup> Bethel Business and Community Development Centre

Mokhotlong at Matsoaing village was built. The project was successfully implemented and helped increase crop yields.<sup>68</sup>

There are 2.28 million hectares (ha) of agricultural land in Lesotho; as of 2014 about 0.05 percent of this land or 1,200 ha was irrigated.<sup>69</sup> The GoL in Vision 2020 has set a goal to increase irrigation to 20,000 ha by 2020. Assuming 5 kWp<sup>70</sup> solar irrigation pumps are used to achieve the 2020 goal there is the potential for 7,500 solar irrigation systems or 37.5 MW of solar irrigation capacity.

### **Solar street lights**

Solar street lighting uses a solar PV module to accumulate power in a digitally controlled battery. The power is discharged at night to power efficient light-emitting diode (LED) light sources. Such systems can also be used as public charging stations for small electronic devices. Solar LED street lights can last up to 15 years (60,000 working hours), three times longer than conventional lighting technologies. Solar street lights are available from 10 W to 100 W in different capacities; batteries typically come with a five-year warranty. A 50 W LED street light would have 160 W solar panels, and 820 W battery pack, PVM charging, and dimming and day/night timing sensors. Figure 4.8 shows a solar street light installed at Lesotho Agricultural College.

The available data on solar street lighting was limited to Maseru. As of March 2017, the Municipal City Council of Maseru has installed 21 solar street lights in Maseru along Hilton and Orpen roads. There remains 707 conventional street lights in Maseru City that could be replaced with solar lights, representing a potential to install 133 kWp in solar that would produce approximately 129 MWh annually<sup>71</sup>. Additional opportunities exist for solar street lights to replace conventional street lights in other towns or to bring street lighting to areas where it does not yet exist, but information was not sufficient to provide an estimate of this potential.

**Figure 4.8: Solar Street Light, Lesotho Agricultural College**



Source: Sunfor Technologies

<sup>68</sup> Draft Terminal Evaluation Report of the Lesotho Renewable Energy-Based Rural Electrification Project, 2013.

<sup>69</sup> World Bank Development Indicators.

<sup>70</sup> A horsepower system is typically appropriate for irrigation of 2 ha (GIZ. "Frequently asked questions on Solar Irrigation Pumps"). Therefore, we assume a 5 kW pump can be used to irrigate approximately 2.5 ha.

<sup>71</sup> Assumes that a 50 W lamp produces light for 10 hours a day.

## **Clean cook stoves**

Cook stoves that use biomass, such as fuel wood, are the primary source of thermal energy used throughout Lesotho. Current cook stove technology consumes almost 90 percent of biomass fuels, including shrubs, firewood, crop residue, and animal waste. Improved cook stoves are up to 50 percent more efficient compared to traditional stoves and provide health benefits by reducing the amount of emissions in the home. Approximately 4,560 African Clean Energy (ACE) and 10,000 Solar Lights cook stoves have been sold in Lesotho; the estimated total available market is about 353,000 households.<sup>72</sup> The GoL through its research and development centre, Appropriate Technologies Services (ATS), is also developing affordable efficient cook stoves that have a dual function for space heating. ATS is also trying to develop other energy efficient household technologies including solar fruit and vegetable driers, commercial scale solar box cookers, and solar hot water collectors.

Solar clean cook stoves have also been tested in Lesotho. A study conducted by the Program for Biomass Energy Conservation asked households to test various types of solar cookers to determine the acceptance level of these technologies, including large parabolic solar cookers, small parabolic solar cookers, and solar box cookers. The study found that most users wanted to own a solar parabolic cooker because of the time and energy saved from not having to gather firewood for cooking.<sup>73</sup> It is estimated that over 900,000 metric tons of common biomass could be saved annually in Lesotho with full conversion to clean cook stoves.

## **4.3 Availability of Financing for Renewable Energy Projects and Technologies in Lesotho**

The commercial banking sector in Lesotho is small and access to credit is considered the greatest challenge to doing business.<sup>74</sup> Private credit, which has increased in recent years, has been attributed to growth in personal loans and mortgages, while credit for the private sector has remained stagnant at around 15 percent of GDP since 2010.<sup>75</sup> There are no commercial financing facilities specifically for RE projects. Existing projects are mostly financed by development partners. The sub-sections below describe RE projects and technologies that are being financed by development partners and Government, as well as private sector RE activities.

### **4.3.1 Role of private sector and NGOs in financing RE**

In the absence of commercial financing from banks in Lesotho, the private sector relies on grants and vendor innovation for ways to deliver RE technologies to the Basotho. Private sector and NGO activity in the RE sphere is mostly limited to seven players that focus their efforts on distributed RE technologies such as efficient cook stoves, SHS, and bio-digesters. There are also some private companies with interest in becoming independent power producers. Table 4.15 summaries the key private sector players in Lesotho's RE sector.

---

<sup>72</sup> African Clean Energy Survey (Lesotho); Berkley Air ACE Study Cambodia, 2015; GEF SGP Project Proposal – Improved Stoves, 2012.

<sup>73</sup> ProBEC, Final Assessment of Cooker Testing in Lesotho.

<sup>74</sup> International Monetary Fund, "IMF Country Report," 2016.

<sup>75</sup> International Monetary Fund, "IMF Country Report," 2016.

**Table 4.15: Summary of Key Private Sector and NGO Entities in RE**

Type of Entity	Business	Name	RE Technology	Financing and Delivery Mechanism
Private sector	RE vendor	African Clean Energy	Efficient cook stoves with battery of up to 150kWh charge, 5W PV panel, LED light, and USB charging port	Microfinance loans through Kiva
Private sector	RE vendor	Solar Lights	Efficient cook stoves with heat retaining bag, three pots and lids	12-month payment plan; carbon credit scheme which subsidizes cost of product
Private sector	RE vendor	Venus Dawn Technologies	Solar geysers, solar PV, solar street lights	No information available
Private sector	RE vendor	The Solar Company	Solar PV, Solar thermal	Price include installation and 2 years maintenance
NGO	Re vendor	Technologies for Economic Development	Biomass digesters	Two-part payment plan (40 percent down payment, 60 percent upon installation)
Private sector	RE vendor/IPP <sup>76</sup>	Monsun Clean Energy Technologies	Solar PV, Solar SHS, SWH, Utility-scale solar	Upfront payment
Private sector	IPP	One Power Africa	Solar Microgrids, Utility-Scale Solar	Power purchase agreement (post-pay for utility-scale projects)/ Pay-as-you-go and payment plan for connection (pre-payment for microgrids)
NGO	RE Vendor	Bethel Business & Community Development Centre/ SOLTRAIN	SWH	50 % grant, remaining portion paid by consumer



Absent support from Government or MDBs the availability of financing is vendor-specific. As shown in Table 4.15, some vendors require upfront payments for the RE technology while others offer financing mechanisms to enable poorer households to finance their purchases. ACE, an RE vendor that manufactures and distributes clean cook stoves in Lesotho, works with Kiva, an international microfinance NGO to provide micro loans to rural households for the purchase of the stove(s). The loans are interest free and spread out the cost of the cook stove (US\$ 99) minus an upfront deposit over 9 months. Solar Lights, another RE vendor that assembles and distributes efficient cook stoves and heat retaining containers in Lesotho, subsidizes the cost of investment through a carbon credit agreement with Deutsche Post and offers its customers a 12-month interest free payment plan to payback the reduced upfront cost of the stove and heat retaining container.

There are no IPPs operating in Lesotho, but the GoL is in the process of procuring a 20 MW solar park. When the DoE has completed negotiations with its preferred bidder, a PPA will be established to finance the construction and deployment of the solar park.

#### **Development partner activities**

There are four bilateral and multilateral development partners that currently provide technical assistance and financing for RE projects in Lesotho. The indicative funding envelope for these activities is M 773.6 million (US\$ 58.1 million).<sup>77</sup> Most of the funding is dedicated to technical assistance to develop the RE enabling environment and pilot off-grid RE solutions. Table 4.16 summarizes ongoing development partner projects.

---

<sup>76</sup> IPP refers to independent power producer

<sup>77</sup> Official exchange rate as published on the Lesotho central bank website: 1US\$ = 13.3078 Maloti.

**Table 4.16: Summary of Ongoing Development Partner Projects**

Development Partner	Projects	Objective/ Description	RE Sources	Funding (M Million)
	Support to Climate Change Response Planning Strategy	Preparation of National Climate Change Policy & Strategy and National Sustainable Energy Strategy	Various	11 <sup>78</sup>
EU	Support to Reform in the Energy Sector	<ul style="list-style-type: none"> <li>▪ Preparation of sector plans, electrification Master Plan, capacity development plans, and resource maps</li> <li>▪ Redefining mandates of institutions in the energy sector</li> <li>▪ Establishment of pilot microgrid solutions in economically suitable areas</li> <li>▪ Pilot distribution of energy efficient household devices (clean cook stoves, SHS)</li> <li>▪ Development of the Energy Law</li> </ul>	Microgrid, distributed RE technologies	105
UNDP/GEF	Development of Cornerstone Public Policies and Institutional Capacities to Accelerate SE4ALL Progress	<ul style="list-style-type: none"> <li>▪ Development policies and strategies to promote private sector investment in microgrids</li> <li>▪ Development of SEA4ALL country agenda and investment prospectus</li> <li>▪ Conduct national energy baseline survey</li> <li>▪ Harmonization of energy data with national energy policy and climate change strategy</li> <li>▪ Pilot 10 microgrids</li> <li>▪ Pilot 10 energy centres (for distribution and demonstration of RE technologies)</li> </ul>	Microgrid, distributed RE technologies	300

<sup>7878</sup> Funding for EU projects are based on a 1€ = 15M exchange rate.

<b>Development Partner</b>	<b>Projects</b>	<b>Objective/ Description</b>	<b>RE Sources</b>	<b>Funding (M Million)</b>
Government of Italy	Implementation of Memorandum of Understanding in the Field of Climate Change Vulnerability, Risk Assessment, Adaptation and Mitigation	Development of RE resource maps	Solar, wind, hydro	6.9
AfDB	Urban Distribution Rehabilitation and Transmission Expansion Project	Rehabilitation and expansion of distribution and transmission network Preparation of energy resource map	Solar, wind, hydro	188

#### **4.4 Key Barriers to Scaling-Up Renewable Energy and Proposed Mitigation Measures**

Investments in RE can be a solution to Lesotho’s energy sector challenges—such as energy security, energy access, and declining biomass stocks—and serve as a cornerstone to improving economic and health prospects of the Basotho.

As described in Table 4.16 above, some RE projects are underway with development partner and private sector support, but a substantial proportion of Lesotho’s RE potential remains untapped. There are regulatory and institutional, technical, financial, environmental, and social barriers that must be addressed to enable the uptake of RE technologies. Table 4.17 summarizes the key barriers to scaling-up RE and some proposed mitigation measures.

**Table 4.17: Summary of Barriers to RE and Potential Mitigation Measures**

Category	Specific Barrier	Potential Mitigation Measure
<b>Regulatory and Institutional</b>	<p style="text-align: center;"><b>Incomplete legal and regulatory framework</b></p> <p><i>First, while the Lesotho Energy Policy (2015-2025) provides a strategy for the energy sector for the next decade, this strategy has not been legally established creating uncertainty over the plan for the sector. Second, a draft RE framework policy (what are we referring to?), legislation (I am not aware of this legislation), and regulations have been developed with instruments for procuring both off-grid and on-grid RE but many parts of the framework have not yet been adopted creating an uncertain investment climate for RE investors. Moreover, specific regulations for off-grid RE deployment need to be developed. (section 3.1.2)</i></p>	<ul style="list-style-type: none"> <li>▪ <i>Prioritize the update and adoption of the Lesotho Energy policy (2015-2025) and enactment of an Energy Law that sets the policy into Law.</i></li> <li>▪ <i>Prioritize the adoption of the remaining pieces of LEWA’s draft RE Regulatory Framework. This will done formally within the Energy Act to be put in place in 2018.</i></li> <li>▪ <i>Develop separate regulations (technical, process, and economic) for private sector participation in off-grid electrification, including clear provisions for areas that will eventually be served by the main grid</i></li> <li>▪ <i>Establish clear RE targets</i></li> </ul>
	<p style="text-align: center;"><b>Overlapping institutional mandates of various energy sector entities</b></p> <p><i>The institutional responsibilities of various energy sector entities such as the DoE, LEC, LEWA, and REU overlap resulting in an underdeveloped legal and regulatory framework, and slow implementation of projects in the energy sector. (section 3.1.1)<sup>79</sup></i></p>	<ul style="list-style-type: none"> <li>▪ <i>Prioritize the adoption of proposed mandate revisions by the EU</i></li> <li>▪ <i>Invest in capacity building for energy sector entities to prioritize, develop, manage, and implement energy sector projects</i></li> </ul>

<sup>79</sup> Draft findings of the EU EDF-11 Scoping Study noted that there is a lack of clarity on institutional mandates in the energy sector. For example: the mandate for on grid extension can be made clearer as both the REU and LEC are conducting grid extension projects, with less resources being dedicated to off-grid electrification. The DoE’s mandate includes both policy development and implementation. Best practice suggests that those two roles should be separate. Additionally, the energy regulator LEWA is also currently responsible for administering the UAF, a role that is typically delegated to a policy development entity, which decides how the fund should be used, while the funds are managed by a finance entity. LEWA also set electricity connection targets, another role that is typically delegated to a policy development entity.

	<p><b>Lack of technical standards for RE installations and appliances</b>  <i>Imported distributed RE technologies are often low quality</i>  <i>Buildings do not meet any energy efficiency standards</i></p>	<ul style="list-style-type: none"> <li>▪ <i>Develop RE technical standards for construction, buildings, and appliances</i></li> </ul>
<b>Technical/Capacity</b>	<p><b>Inadequate baseline data and studies</b>  <i>Irregular, outdated, and incomplete statistical reports and surveys hinders informed policy making</i></p>	<ul style="list-style-type: none"> <li>▪ <i>Support to prepare up-to-date and comprehensive energy baseline studies</i></li> <li>▪ <i>Incorporate training for officials in data collection and analysis (ongoing<sup>80</sup>)</i></li> </ul>
	<p><b>Lack of centralized waste collection and segregation facilities</b>  <i>Absence of waste collection and sorting facilities raises upfront costs for waste-to-energy plants</i></p>	<p><i>Conduct a study to determine the feasibility of waste collection and segregation services in the districts</i></p>
	<p><b>Need for training from the institution to end-user level</b>  <i>Lack of experience and capacity within government limits their ability to coordinate and implement RE projects.</i>  <i>Little domestic expertise to install and maintain RE technologies</i></p>	<ul style="list-style-type: none"> <li>▪ <i>Provide on-the-job training to government officials to manage, coordinate, and implement RE projects</i></li> <li>▪ <i>Expand RE technologies curriculum at the National University of Lesotho</i></li> </ul>
<b>Environmental</b>	<p><b>Increasingly variable rainfall and risk of drought</b>  <i>Variable output from HPPs limits their financial viability</i>  <i>Increased flooding and siltation impacts the operational performance of HPPs</i></p>	<p><i>Invest in flood protection measures such as dam monitoring equipment and spillways</i></p>
	<p><b>Limited availability of suitable land for RE development</b>  <i>Competing land resources such as agriculture, expanding settlements, and protected areas limits development</i>  <i>Mountainous topography limits areas for RE development</i></p>	<p><i>Integrate RE technology with existing structures and promote small-scale RE development</i></p>

<sup>80</sup> The UNDP's Development of Cornerstone Public Policies and Institutional Capacities to Accelerate SE4ALL Progress project is providing support to the GoL in this area.

<b>Financial</b>	<p><b>Limited access to financing and underdeveloped delivery mechanisms</b></p> <p><i>Low income and rural households have limited or no access to RE technologies and often cannot afford them</i></p>	<p><i>Formulate or leverage existing financing mechanisms such as microfinance, and mobile banking</i></p>
	<p><b>Difficulty for private sector to access RE financing</b></p> <p><i>Lack of access to credit limits the scaling-up of RE investments</i></p>	<ul style="list-style-type: none"> <li>▪ <i>Establish renewable energy funding schemes to incentivize investment</i></li> <li>▪ <i>Introduce economic incentives for utility-scale RE development</i></li> </ul>
	<p><b>High cost of distributing RE technologies</b></p> <p><i>Challenging topography and underdeveloped transmission and transport infrastructure raises costs for distributing RE technologies</i></p>	<p><i>Establish energy distribution centres and microgrids in remote villages (proposed by EU and UNDP)</i></p>
<b>Social</b>	<p><b>Lack of awareness and aversion to change</b></p> <p><i>Lack of awareness about the health and cost benefits of RE technologies among Basotho limits RE uptake</i></p>	<p><i>Market the benefits of new-technologies through awareness programs and mobile demonstrations</i></p>

## 5 Financial and Economic Viability of Renewable Energy Technologies

This section goes beyond the assessment on resource and technical capacity to provide additional factors for consideration when determining a technology’s viability and attractiveness for inclusion in Lesotho’s SREP IP. The next steps in screening potential RE investments are to consider the economic and financial viability of the identified technical capacity. Both economic and financial assessments use the levelized cost of energy (LCOE) of the various on-grid and off-grid RE technologies to evaluate the viability of the estimated production of each of those technologies. Appendix F provides an explanation of how LCOEs are calculated and their general use in evaluating energy investments.

Section 5.1 summarizes the cost assumptions used in the LCOE calculations. Sections 5.2 and 5.3 present the assessments for economic and financial viability, respectively. Finally, Section 5.4 discusses the costs and affordability for the distributed technologies where LCOE calculations were not appropriate.

### 5.1 RE Technology Costs

The cost assumptions for calculating the LCOEs of each RE technology are based on a combination of costs identified in project documents and where information was either not available or determined to be inconsistent with current market prices we used international costs adjusted for the country context.<sup>81</sup> The cost of grid-connected RE options are “all-in” costs meaning that they are inclusive of all project costs including grid-connection.<sup>82</sup> Assumptions used for grid-connected projects are presented in Table 5.1.

**Table 5.1 Costs Assumptions for On-grid RE Technologies**

	Capital cost (US\$/kW)	Fixed O&M cost (US\$/kW <sub>y</sub> )	Variable O&M cost (US\$/kWh)	Capacity factor (%)	Asset Life (years)
Utility-Scale Solar Park	1,620	16	0	35-36 <sup>†</sup>	20
Wind Farm	2,500	32	0	25-40 <sup>†</sup>	20
Reservoir HPP	4,200	175	0	40-100 <sup>†</sup>	30
Run-of-River HPP	3,500	175	0	40-100 <sup>†</sup>	30

<sup>81</sup> International data was gathered from IRENA; SNL Energy; and UNEP’s Green Economy Report.

<sup>82</sup> In addition to technology components the all-in costs include: land, civil engineering, DC cables, SCADA system, data system, transmission line, and installation and design. The inclusion of these costs might make the capital costs used in the IP appear to be relatively high compared to other CAPEX estimates that only include the technology specific components.



Small Rehab* HPP	2,800	175	0	50-100 <sup>†</sup>	30
Waste-to-Energy Plant	3,750	115	0.0243	70	25

Note: Variable O&M cost includes the cost of fuel; with the case of solar microgrids this is the cost of fuel for backup generators. Fuel costs for waste-to-energy plants assume a heat factor of 18,000 BTU/kWh.

\* Parameters for rehabilitation of the Tsoelike and Tlokoeng HPPs.

<sup>†</sup> Capacity factor varies by location

The technologies included in the off-grid LCOE analysis were microgrids, SHS, solar water pumps, and solar irrigation. As with on-grid options the cost assumptions for off-grid technologies were identified from existing project documents and supplemented with international cost data. Assumptions used for off-grid RE technologies are presented in Table 5.2.

**Table 5.2 Costs Assumptions for Off-grid RE Technologies**

Technology	Capital Cost (US\$/kW)	Fixed O&M Cost (US\$/kW <sub>y</sub> )	Variable O&M Cost (US\$/kWh)	Capacity Factor (%)
Solar Microgrid	5,500 (Type A) 5,750 (Type B)	50*	0.0020	31-33 <sup>†</sup>
Floating Microgrid HPP	6,405*	125	0	40
Solar Home Systems	14,600	324	0	24 <sup>†</sup>
Solar Irrigation Pumps	2,600	175	0	35

Note: Microgrid costs include representative cost of wires and meters needed to serve local customers.

\* O&M costs for solar microgrids includes the cost of fuel for diesel back up.

<sup>†</sup> Capacity factors for microgrids and SHS are based on end-user consumption, not generation potential.

## 5.2 Economic Viability Analysis

The goal of the economic viability analysis is to understand how the identified RE capacity in Lesotho compares with its opportunity cost of generation. For this purpose, LCOEs of the on-grid options are compared to the avoided cost of imported electricity and off-grid RE options are compared to the avoided cost of off-grid diesel generation. The technology costs—not including financing costs—are discounted over the lifetime of each option at

the social cost of capital (six percent).<sup>83</sup> The economic analysis is meant to demonstrate how competitive each RE option would be in Lesotho regardless of the cost of financing.

Supply curves are used to present the results of the LCOE calculations under the economic viability scenario. A supply curve<sup>84</sup> is the cumulative generation of the technically viable identified RE options ranked from lowest to highest in accordance to the calculated LCOEs. When reading the supply curves, technologies that have lower economic costs are lower on the curve and any technology that falls below the opportunity cost of generation (represented by the dashed line) are demonstrated to be economically viable. The economic scenario supply curves for on-grid and off-grid are shown in Figure 5.1 and Figure 5.2 below.

**Figure 5.1: Economic Viability On-Grid RE**

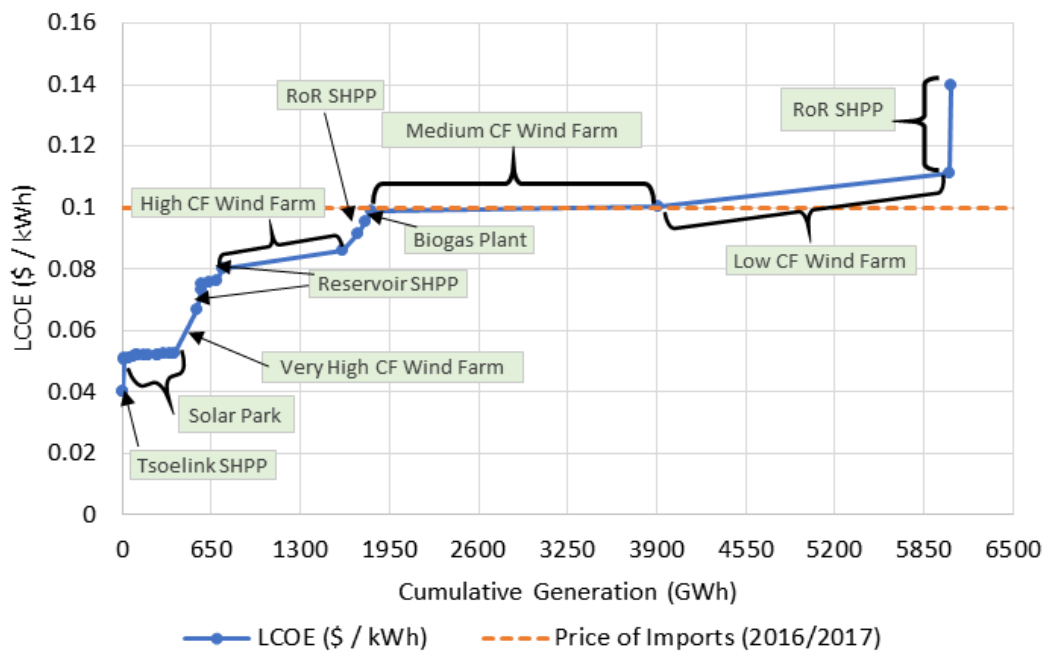

<sup>83</sup> Because different technologies have different asset lives a discount rate is used to bring all costs to a net present value so that there is a common point of comparison across technologies. Historically the social opportunity cost or economic cost of capital has been set at standard 10-12 percent by most MDBs when evaluating projects in developing countries. In recent years, notes at the World Bank (“Discounting Costs and Benefits in Economic Analysis of World Bank Projects” Guidance note, 2016.) and United States Federal Reserve (Warusawitharana, Missaka. “The Social Discount Rate in Developing Countries.” FEDs Notes. 9 October 2014) have questioned whether this standard should be continued. The Guidance Note recommends that a base of six percent be used going forward and that a sensitivity analysis be done to see the effects of increasing/decreasing the rate to ensure that projects are not being eliminated/selected based on some arbitrary cut-off. When preparing the IP, a 10 percent social cost of capital was tested. The most significant outcome when the 10-percent standard is that all grid-connected wind projects, even the best resources, are no longer economically viable. This result, however, is not particularly interesting because the overall ranking of the projects stayed relatively the same with solar PV still showing to be the most economic option. Therefore, the six percent rate recommended in recent studies was used in development of the IP.

<sup>84</sup> The supply curves and LCOEs presented in this IP are meant to be indicative of technology costs and not the actual costs of project sites. Additional resource assessments and specific site surveys are needed to get precise estimates for specific projects.

Note: Wind farm capacity factors are classed as Very High (>45%); High (35-45%); Medium (30-35%); and Low (27.5-30%); the import price is the average import price LEWA approved for inclusion in LEC's 2016/2017 revenue requirement.

RoR SHPP: Run-of-River Small Hydropower Plant.

---

Figure 5.1 shows that most on-grid technologies are economically viable in Lesotho with solar PV proving to be consistently among the cheapest options—only some wind and small HPP projects with low capacity factors are not economically viable options. These results should be expected given the high resource potential identified in Lesotho and a relatively high cost of imports—average of US\$0.10 /kWh in 2016/2017.

Off-grid economic viability results for all technologies are not as pronounced. The LCOEs of microgrids powered by floating hydropower, solar water pumps, solar irrigation pumps, and solar PV-battery microgrids all fall below the cost of off-grid diesel generation. Conversely, all SHS are far above the cost of this economic viability threshold. The results for both types of microgrids and water pumps are consistent with results seen elsewhere in Africa and other developing countries where the high cost of transporting diesel fuel to rural areas makes a strong economic case for RE powered services. SHS is shown to not be economically viable when compared to the cost of off-grid diesel generation.

While diesel generation may be an appropriate comparison for the services provided by a microgrid or solar pump, diesel generation may not be the most representative replacement for the basic energy services offered by SHS. The more appropriate comparison is likely to be household expenditure on candles and kerosene. Rural households are estimated to spend around US\$24 per month on these items.<sup>85</sup> If the use of SHS can completely replace these products the value of the energy provided by SHS could be as much as US\$ 2.25 per kWh<sup>86</sup>—well above the US\$ 77 per kWh LCOE for SHS shown below.

---

<sup>85</sup> Africa Clean Energy (ACE) survey of rural households prior to purchasing

<sup>86</sup> This estimate assumes 0.35 kWh of energy use per day (or 10.5 kWh per month) from a 65w SHS. US\$ 24 / 10.5 kWh = US\$ 2.25 per kWh.

**Figure 5.2: Economic Viability Off-Grid RE**

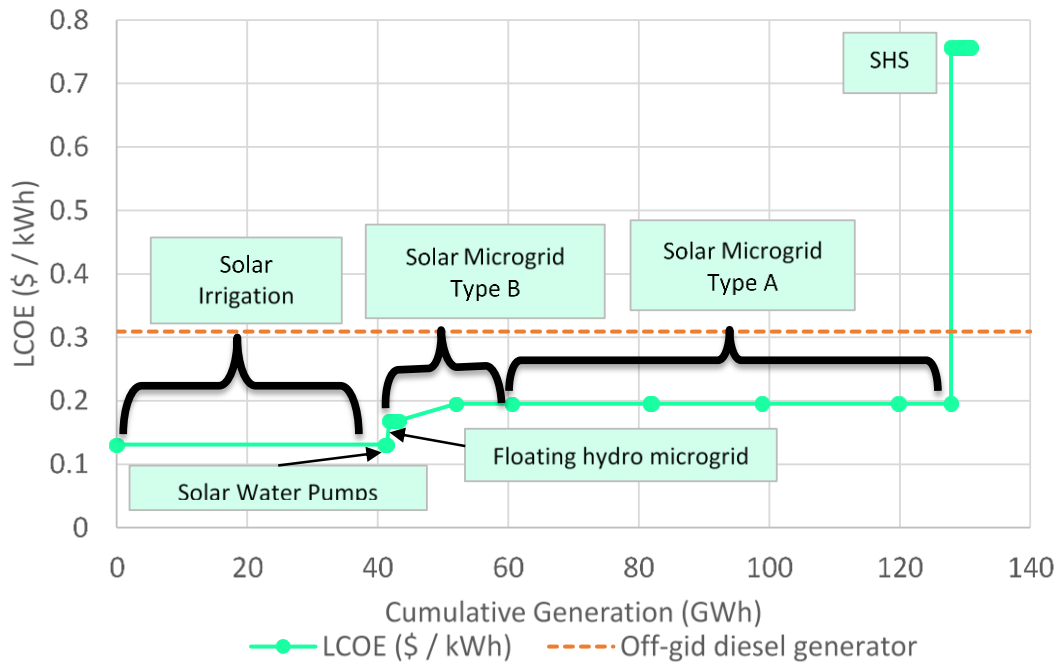

Note: 5kW microgrids are classified as Type A and 8 kW microgrids are classified as Type B. The cost of off-grid diesel generation is calculated using the following assumptions: a capacity factor of 50%; cost of diesel at US\$ 1 per liter; a heat rate of 10,000 BTU per kWh; capital expenditure (CAPEX) of US\$ 800 per kW; and an asset life of 10 years.

SHS = Solar Home Systems

### 5.3 Financial Viability Analysis

The financial viability analysis seeks to identify the RE technologies that will be most attractive to investors. The financial analysis LCOEs are calculated inclusive of financing and again compared to the cost of imported electricity (on-grid) and diesel generation (off-grid). As a first-level assessment commercial financing terms were used to evaluate financial viability to demonstrate the potential for each technology to attract private investment. An alternative scenario based on concessionary financing is also considered. Terms for both scenarios are presented in Table 5.3.

**Table 5.3: Financing Terms of Financial Viability Scenarios**

	Commercial	Concessional
Debt/equity split (%)	70/30	100/0
Debt rate (%)	13*	3.3
Equity return (%)	20.00	0
Debt term (years)	7 (off-grid); 12 (on-grid)	20

\* Prime interest rate in Lesotho as of December 2016 is 12.3 percent.

The supply curve results for financial viability under private sector financing of on-grid and off-grid RE technologies are shown in Figure 5.3 and Figure 5.4 below. When reading the figures, any investment at or below the viability threshold (represented by the dotted line) are considered financially viable. The premise of “viability” here means the cost of energy being produced is on par or cheaper than the cost of energy being replaced (i.e., imports or off-grid diesel generation).

**Figure 5.3: Financial Viability (Commercial Financing) On-Grid**

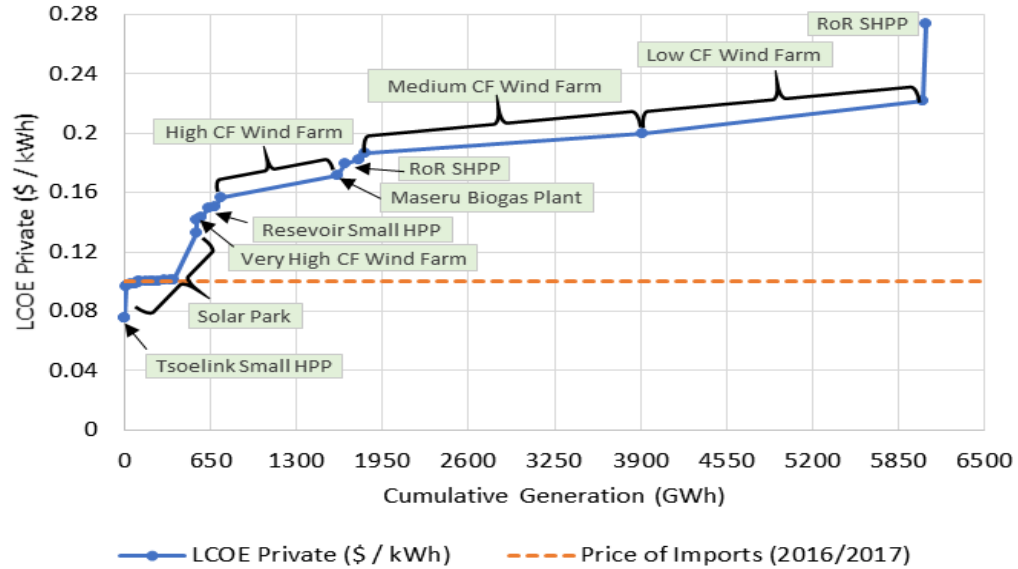

**Figure 5.4: Financial Viability (Commercial Financing) Off-Grid**

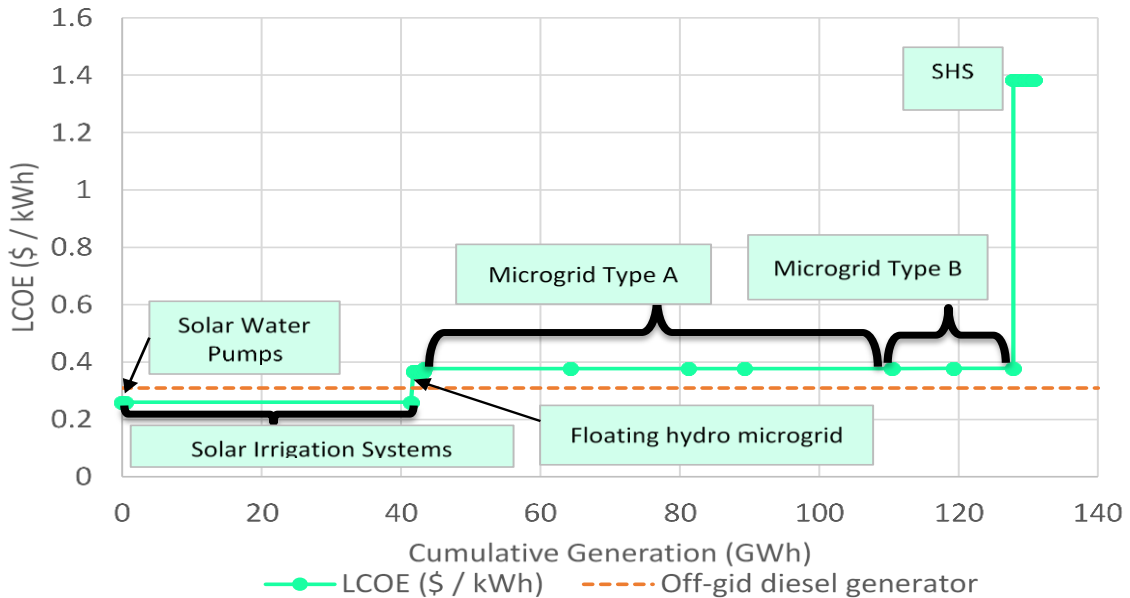

As evident in Figure 5.3 most of the on-grid generating potential is not currently financially viable. These results are to be expected in a country where there is little to no experience with many of these technologies on a utility-scale. The cost assumptions used are based on the costs of a “first-mover” project that are likely to incur higher costs developing a supply chain and building local capacity than similar projects in an established market. Once the market for these technologies is established costs are anticipated to drop over time and the financial viability would improve. For example, if the capital costs for wind fall from the US\$2,500 per kW assumed to US\$2,000 per kW the LCOE of the highest capacity wind projects achieve financial viability—dropping from US\$0.13 /kWh to US\$0.10 /kWh under the same financing scenario. Increased experience and a more supportive regulatory framework could also reduce the cost of financing. If the interest rate and return on equity in the private financing scenario both drop by 300 basis points (i.e. to 10 and 17 percent) the LCOE of the identified Thaba-Tseka HPP falls from US\$ 0.14 /kWh to US\$0.095 /kWh, and the plant becomes financially viable.

The results for off-grid financial viability also show that most technologies are not currently financially viable. Microgrids, however, appear to be on the verge of being competitive, but this is purely on a project cost basis. If, as Figure 5.4 shows, that microgrids could be delivered at this cost already one would expect there to already be an active market in Lesotho. The fact that there is not an active microgrid market shows there is another factor barring investment. One hypothesis is that developers considering or investigating a microgrid project may be finding it not financially viable once they account for the greater risks of acting both a generator and service provider, often to less affluent rural customers.

SREP funds could play a key role in improving the financial viability of RE technologies in Lesotho. Concessional funds, such as those from SREP, are often used to support pioneer projects that will establish an RE market and help bring down both the technology and financing costs for subsequent projects. SREP funds would bridge the gap between the economic and financial viability scenarios to bring RE capacity online that will be beneficial to Lesotho but may not currently be attractive to investors at market rates. To emphasize this point, an additional financing viability scenario was run using concessional debt terms (see Table 5.3 above) and provided in Figure 5.5 and Figure 5.6. The switch from private financing terms to concessional financing makes all but a couple options/projects financially viable.

**Figure 5.5: Financial Viability (Concessional Financing) On-Grid**

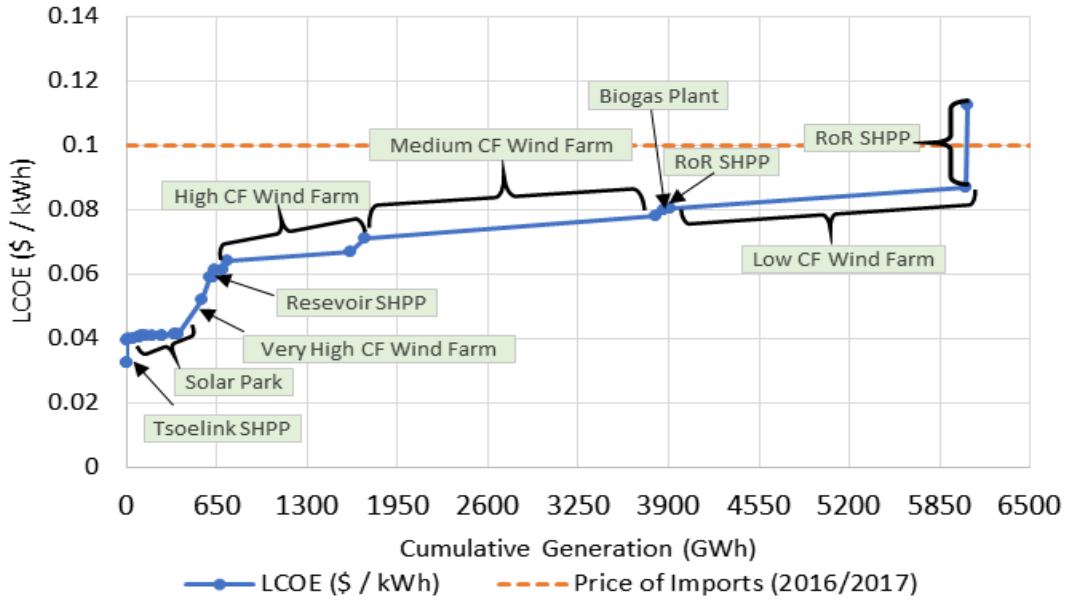

**Figure 5.6: Financial Viability (Concessional Financing) Off-Grid**

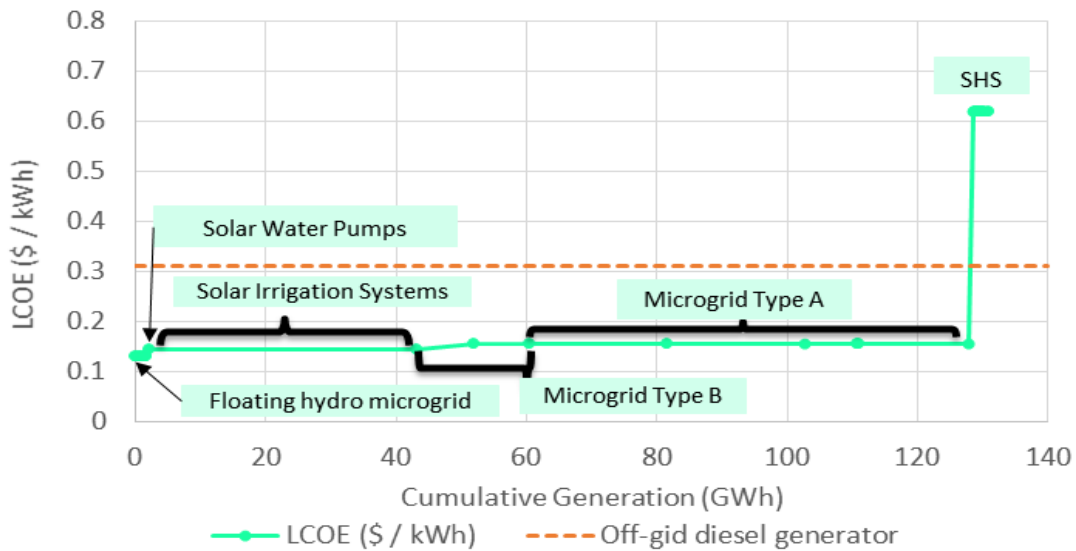

#### 5.4 Cost of Other Distributed RE Technologies

An LCOE is not the most appropriate measure to assess the cost viability of the remaining technologies. Instead in this section we present a summary of the costs of the remaining technologies and provide a basis for comparison where data was available.

### **Solar street lights**

The Maseru City Council estimates that it would cost M 300 million (US\$ 23.56 million) to both replace the existing 707 conventional street lights and meet additional street lighting needs in the city district with solar street lights. Additional information is needed on the exact number of street lights that would be installed under this plan. As a comparison, the capital cost of one solar powered street light in South Africa ranged from US\$ 1,440 to US\$ 1,800.

### **Efficient cook stoves**

A financial assessment of cook stoves can be conducted by comparing current household energy expenses to the amount they could be spending with a clean cook stove – the cost of cook stoves vary by vendor. In Lesotho, the private sector offers interest free financing to households to purchase a clean cook stove. According to ACE – one example of a private sector cook stove vendor – estimates, households spend on average M 324 on energy each month. The cost of an ACE stove is US\$ 99, or M 1330. An initial down payment of M 250 is required for the stove while the remainder is collected in monthly payments of M 120 over the course 9 months. Because the ACE stove comes with a small solar PV panel, LED light, and charging outlet, Basotho households can substantially reduce household expenditures on energy. Moreover, the payment plan helps rural Basotho households that have cash flow problems afford the product.

### **Solar water heating**

A solar water heating system (SWHS) consists of a solar water heating panel and an adjoining water tank. Capital costs varies by size, type and source of the manufacturer but are approximately US\$ 2,000 per watt. Average lifetime of these systems is about 20 years, but typical manufacturer warranties are for 5 years. Additional information on targets for SWHS and the systems available for sale in Lesotho are needed to better assess the costs.



## 6 Prioritization of Renewable Energy Technologies

Many of the technologies described in Sections 4 and 5 are important for Lesotho, but some are better candidates for SREP support than others. This section prioritizes technologies based on SREP criteria and criteria identified during the Inception Mission and follow-up consultations with stakeholders and then provides recommendations.

Each technology was scored against the SREP and government criteria. A scoring scale of one to five was used; one being the lowest score, and five being the highest. Table 6.1 defines and describes how the technologies were evaluated against the SREP selection criteria. Table 6.2 defines and describes how selection criteria that are in line with the GoL's national goals were evaluated.

**Table 6.1: SREP Criteria for Technology Prioritisation**

<b>Criteria</b>	<b>Description</b>
<b>Increased installed capacity from RE sources</b>	Technologies that increase installed generation (MW) of RE sources are ranked higher. Technologies were ranked based on the technical potential results presented in section 4.1.
<b>Increased access to energy through RE</b>	Technologies that directly increase the number of Basotho with access to modern energy services are ranked higher. Technologies with an indirect impact on access to modern energy sources are ranked lower.
<b>Low emissions development</b>	Technologies that have the lowest carbon emissions when operating were ranked higher.
<b>Increased affordability and competitiveness of RE sources</b>	Technologies that increase the affordability of RE technologies and competitiveness of RE markets in Lesotho are ranked higher. On-grid technologies with lower LCOEs were ranked higher. Off-grid and distributed technologies that are cheaper than diesel generators and the most affordable for households were ranked higher.
<b>Increase in the productive use of energy</b>	Technologies that contribute to increasing income levels and productivity of the Basotho are ranked higher. On-grid technologies that are likely to provide firm power during peak demand hours were ranked higher. Off-grid and distributed technologies that directly contribute to specific productive purposes that result in increased income levels were ranked higher.
<b>Economic, social, and environmental development impact</b>	Technologies that result in positive economic, social, and environmental development impact are ranked higher. Technologies that result that collectively increase









	economic, social, and environmental abatement are ranked higher.
<b>Level of economic and financial viability</b>	Technologies that have a higher level of economic and financial viability (lower LCOE) are ranked higher. Technologies that are financially viable are ranked higher. Technologies that require subsidies or highly concessional financing are ranked lower.
<b>Leverage</b>	Technologies that trigger additional projects, result in investments from other donors or private sector, and catalyze energy sector reforms are ranked higher. Technologies with proven private sector and donor interest, and a high number of potential investment opportunities were ranked higher.
<b>Gender</b>	Technologies that directly promote gender inclusiveness, increase opportunities for women, and decrease the domestic burden on women are ranked higher.
<b>Co-benefits of RE scale-up</b>	Technologies that result in additional benefits in other sectors are ranked higher; e.g., improved solid waste management, or increase in agricultural productivity etc.









**Table 6.2: Government Criteria for Technology Prioritization**









<b>Criteria</b>	<b>Description</b>
<b>Job creation</b>	Technologies that directly create jobs for the Basotho are ranked higher than those that result in temporary employment during construction.
<b>Increases energy security</b>	Technologies that increase Lesotho's energy security (reduces imports, increases reliability of energy supplies) are ranked higher. On-grid technologies are ranked by the average resource capacity factor. Off-grid and distributed technologies that provide higher quality and more reliable energy to households are ranked higher.
<b>Promotes private sector involvement in energy sector</b>	Technologies that directly support or catalyze private sector participation in the energy sector are ranked higher. On-grid technologies that have greater potential for a demonstrative impact with SREP support are ranked higher. Off-grid technologies that can be scaled-up with SREP support are ranked higher.









Table 6.3 shows the ranks each technology by each criterion, and provides brief explanations for why each technology received a particular ranking.

**Table 6.3: Evaluation of RE Technologies against SREP and GoL Criteria**

Criteria	On-Grid				Off-Grid			
	Solar PV 	Wind 	Small HPP 	Waste-to-Energy 	Microgrids 	SHS 	Other solar 	Cookstoves 
<b>SREP Criteria</b>								
Increased installed capacity from RE	<b>4</b> Second highest buildable capacity (119 MW) of on-grid technologies	<b>5</b> Highest buildable capacity (286 MW) of on-grid technologies	<b>3</b> 35 MW identified capacity, resource studies could identify more	<b>2</b> Technical potential in Maseru but unclear if possible in other districts without established waste collection	<b>3</b> Highest buildable MW capacity for off-grid, 31.5 MW	<b>1</b> High potential of installed units, but low in capacity, 1.4 MW	<b>2</b> Technologies mostly provide services, not energy capacity	<b>1</b> Depends on technology, some include built-in battery/solar PV
Increased access to energy through RE	<b>2</b> Indirectly supports access, new supply potentially enables more connections	<b>2</b> Indirectly supports access, new supply potentially enables more connections	<b>2</b> Indirectly supports access, new supply potentially enables more connections	<b>2</b> Indirectly supports access, new supply potentially enables more connections	<b>5</b> Highest potential to directly provide electricity access to households	<b>4</b> Will directly provide access to households	<b>1</b> Technology provides other benefits, not direct access to energy	<b>4</b> Technologies lower fuel requirements, thus providing easier access to energy
Low emissions development	<b>5</b> Zero GHG emissions	<b>5</b> Zero GHG emissions	<b>5</b> Zero GHG emissions	<b>2</b> Lower emissions than fossil fuel-based generation, but higher than other RE options	<b>5</b> Zero GHG emissions	<b>5</b> Zero GHG emissions	<b>5</b> Zero GHG emissions	<b>3</b> Substantial reduction in GHG output but not all improved cookstove technologies eliminate emissions completely
RE affordability & competitiveness	<b>5</b> Competitive with imported energy	<b>2</b> Only best resources	<b>3</b> Second lowest average cost of	<b>2</b> Higher cost than imports, subsidy	<b>3</b> Competitive with diesel	<b>1</b> Subsidies needed for affordability	<b>3</b> Solar pumps competitive with	<b>5</b> Investment pays for itself within a

Criteria	On-Grid				Off-Grid			
	Solar PV 	Wind 	Small HPP 	Waste-to-Energy 	Microgrids 	SHS 	Other solar 	Cookstoves 
	under both financing scenarios	competitive with imports under private financing, other sites require subsidies	grid-connected technologies, requires small subsidy to be competitive with imports	required to be competitive	generators, cost might still be too high for rural customers		diesel pumps, other tech. unclear	few months from offset fuel costs
Productive use of energy	<b>3</b> Resource availability aligns closely with demand of commercial and industrial customers that drive daily peak	<b>2</b> Resource may be at available at peak, but not reliable enough for firm power	<b>4</b> HPPs that can provide firm power offer more opportunities for productive use	<b>5</b> Provides reliable firm power for productive uses	<b>5</b> Provides reliable firm power for productive uses	<b>2</b> Provides power that is only sufficient for operation of lights and small appliances	<b>4</b> Power used for specific productive purposes such as improved agricultural yields	<b>2</b> Only for personal use, indirectly increases productivity by lowering time spent on collecting biomass and keeping fire
Economic, social, & environmental development impact	<b>3</b> (+) Offset imports of coal power (-) land competes with agriculture	<b>3</b> (+) Offset imports of coal power (-) Bird/wildlife concerns	<b>3</b> (+) Offset imports of coal gen. power (-) potential water flow issues	<b>4</b> (+) better waste management (-) need to safeguard against waste water disposal	<b>4</b> (+) off-grid economic activity (+) in-home lighting (-) need to properly dispose of battery	<b>4</b> (+) off-grid economic activity (+) in-home lighting (-) need to properly dispose of battery	<b>5</b> (+) local jobs (+) health & safety (+) improved yields	<b>5</b> (+) Lower GHG (+) health benefits (+) social benefits (+) deforestation benefits
Economic and financial viability	<b>5</b> Economically and financially viable now	<b>3</b> Economically viable, financially viable with subsidies	<b>3</b> Viability is site specific, financially viability requires subsidies	<b>3</b> Economically viable, financially viable with subsidies	<b>3</b> Economically viable, and close to financially viable compared to off-grid diesel	<b>1</b> Low viability compared to diesel generator	<b>4</b> Pumps are econ.+ financially viable; other tech. unclear	<b>5</b> Economic and financially viable if investment is financed
Leverage	<b>4</b>	<b>4</b>	<b>3</b>	<b>1</b>	<b>5</b>	<b>5</b>	<b>2</b>	<b>3</b>









Criteria	On-Grid				Off-Grid			
	Solar PV 	Wind 	Small HPP 	Waste-to-Energy 	Microgrids 	SHS 	Other solar 	Cookstoves 
	Already private sector interest, many potential projects	High number of potential projects; once proven costs will fall	Existing resource info. limited, resource study may attract private sector and donors	Limited investment opportunities	Donors already funding projects and developers have interest; many potential projects	Donors already funding projects; many potential projects	GoL already funding water pumps and streetlights, unknown donor or private interest	Some private activity and donors already funding projects
Gender	<b>3</b> Potential job creation and/or increased economic activity improve lives of women	<b>3</b> Potential job creation and/or increased economic activity improve lives of women	<b>3</b> Potential job creation and/or increased economic activity improve lives of women	<b>3</b> Potential job creation and/or increased economic activity improve lives of women	<b>4</b> Mostly benefits households/women by reducing burden of fuel collection/purchasing	<b>5</b> Benefits households/women by reducing burden of fuel collection/purchasing	<b>4</b> Safety benefits from streetlights, improved access to water reduces collection times	<b>5</b> Greatly reduces burden of fuel collection/purchasing on women
Co-Benefits	<b>3</b> Higher resource potential may result in more long-term jobs	<b>3</b> Higher resource potential may result in more long-term jobs	<b>3</b> Less long-term job potential	<b>5</b> Waste collection establishes new job market, improved waste management practices	<b>4</b> Enables increased economic activity in off-grid villages, reduces dependence on more costly energy sources	<b>4</b> Increased safety to households, extends study hours of students	<b>5</b> Tech. can improve access to clean water, crop yields, and public safety	<b>5</b> Supports forest conservation goals, improves household air quality
<b>Additional National Criteria</b>								
Job creation	<b>4</b> Higher resource potential may result in more long-term jobs	<b>4</b> Higher resource potential may result in more long-term jobs	<b>4</b> Multi-year construction jobs, less long-term job potential	<b>5</b> Construction jobs, waste collection would establish new job market	<b>3</b> Vendor and technician jobs	<b>3</b> Supply chain, vendor, and technician jobs	<b>2</b> Technologies enable improvements of existing jobs	<b>4</b> Domestic manufacturing and vendor jobs
	<b>3</b>	<b>2</b>	<b>4</b>	<b>5</b>	<b>5</b>	<b>5</b>	<b>1</b>	<b>3</b>

Criteria	On-Grid				Off-Grid			
	Solar PV 	Wind 	Small HPP 	Waste-to-Energy 	Microgrids 	SHS 	Other solar 	Cookstoves 
Ensures energy security	Peak generation around peak demand, but not reliable	Peak generation does not always align with demand	Best sites can provide reliable base load power	Can provide reliable base load power	High quality reliable power in off-grid areas	Sufficient power to meet household needs in off-grid areas	Tech. not meant to displace or provide energy	Reduces imported fuel requirements, more if fuel produced domestically
Promote private sector involvement in energy sector	<b>5</b> Demonstrative impact of utility-scale pilot can increase private sector participation (PSP)	<b>5</b> Demonstrative impact of utility-scale pilot can increase PSP	<b>4</b> Several potential opportunities, resource assessment could attract more PSP	<b>2</b> One private company interested, but few other opportunities	<b>5</b> Demonstrative impact of pilots can increase PSP	<b>4</b> Innovative financing mechanisms can incentivize PSP in the sector	<b>3</b> Services offered by technologies most likely best provided by GoL	<b>3</b> Distribution centres and financing will help the private sector scale-up their businesses

Source: Emoji icons courtesy of EmojiOne. <<http://emojione.com>>

Table 6.4 provides a ranking of the technologies based on the SREP and national criteria. The top four scoring technologies are recommended for consideration for SREP funding.

**Table 6.4: Prioritization Results**

	Microgrids 	Solar PV 	Cook stoves 	Small HPP 	SHS 	Wind 	Waste-to-Energy 	Other solar 
Score	54	49	48	44	44	43	41	41
Rank	1	2	3	4	4	5	6	6



## 7 Program Description

The prioritization exercise in Section 6 identified two on-grid technologies (solar and small hydro) and three off-grid technologies (microgrids, SHS, and improved cookstoves) that best fit the GoL and SREP objectives for RE investments. At a meeting held to discuss these results in May 2017, the members of The National Task Force<sup>87</sup> agreed that this set of technologies has the most potential to contribute to the primary challenges facing the energy sector: energy security and energy access. These results are also consistent with feedback from the development partners, private sector representatives, and other stakeholders consulted throughout this process (see Appendix C for a list), many of whom emphasized that the sector challenges cannot be overcome with a single resource or technology, but will require a mix of technologies. Based on this feedback the GoL is proposing an SREP IP program that aims to enable a scale-up in all five priority technologies.

Lesotho's proposed SREP program consists of two core investment focused components. Due to the different challenges and business models for the on-grid and off-grid technologies it was decided to separate the program into components for each area. The technical assistance sub-component addresses GoL concerns that a lack of data on project sites limits the possibility of private sector distributed HPP investment. The two components under the program for which the Government will request SREP support are as follows:

- Component 1: On-grid RE technologies
- Component 2: Distributed RE Solutions

The overall goal of this program is to enable increased adoption of the priority technologies through the development of commercial on-grid and off-grid RE markets. This focus aligns with the Government's *Vision 2020* goals to increase private sector investment in infrastructure and promote increased use of RE. SREP funds will be used to facilitate private investment with support to the first privately funded RE projects and provision of technical assistance to develop missing pieces of the enabling environment. With SREP support Lesotho hopes to have a self-sustaining market for on-grid and off-grid investment by the early 2020s.

The DoE will provide overall guidance to the implementation of the proposed SREP program. As the institution responsible for policy setting and sector coordination, the DoE has the functional authority needed to coordinate the activities of the three SREP components. The DoE is already managing the preparation of an RE Mapping Study, Electricity Masterplan, and Energy Action Plan that will be key pieces of the enabling framework used when projects are subsequently prepared. Preliminary implementation arrangements and MDB co-sponsors for each individual component are described in the sections below.

---

<sup>87</sup> The National Task Force is a group of representatives from government agencies, private sector and, non-governmental organizations that was organized to provide guidance to the DoE and their consultant team throughout the IP process.

Sections 7.1 through **Error! Reference source not found.** describe the component activities to be supported with SREP and MDB co-sponsor funds as well as the complementary activities to be carried out by other donor partners. The remainder of the section (7.3 and 7.4) then describe the expected co-benefits and environmental and social risks associated with each project.

## **7.1 Component 1: On-Grid RE Technologies**

The rising cost of imported electricity and concerns about long-term national energy security make increasing investment in grid-connected RE a strategic choice for Lesotho. The GoL has plans to attract private investors through a FiT scheme to help it achieve its goal to meet base load demand with domestic power. The reason a FiT approach has been selected is that it avoids the complex and often lengthy process of managing and evaluating bids and then negotiating a PPA with the winning developer. A challenge to implementing this scheme is the lack of any existing projects to demonstrate that grid-connected RE can succeed in Lesotho. In the absence of a demonstration project, outstanding questions regarding off-taker arrangements, land use agreements, and transmission integration could act as barriers to investors interested in participating in the FiT scheme.

The on-grid RE component will attempt to overcome these challenges by using SREP funds to support the first privately-owned utility-scale RE plant in Lesotho and a study on RE integration that will help LEC and the GoL formulate a strategy for managing the addition of intermittent resources into the national grid. Additional technical assistance will be provided by the MDB co-sponsor to conduct site specific studies for solar PV. The project funding and site studies of this component will specifically focus on development of solar PV projects as the means for establishing an on-grid RE market because the high resource potential and competitive cost of solar make it the technology most likely to attract private investors in the early stages of development. These SREP supported activities will be complemented by a resource mapping study that will provide investors with a list of potential solar, wind, and HPP project sites that could be pursued under the FiT scheme.

### **7.1.1 SREP supported activities**

SREP funds will be used to support the first privately-owned utility-scale RE plant in Lesotho and development of an RE integration study. These activities will be implemented by AfDB. AfDB was chosen to co-sponsor this project because the SREP activities and other complementary activities are related to two of AfDB's previous projects in Lesotho. AfDB is currently working with the DoE and LEC on a transmission and distribution rehabilitation project and previously worked with LEWA to prepare the RE framework that includes the FiT policy to be implemented in parallel to the SREP activities. The familiarity between AfDB staff and many of the stakeholders involved in these activities should enable better communication and collaboration. While it is envisioned that the DoE will be the implementing institution for this component, AfDB will evaluate their readiness and capacity at the time of project appraisal to ensure they are the best institution to manage these activities.

### **Investment in first commercial utility-scale RE project**

The GoL views the successful completion of a privately-owned utility-scale RE plant as an essential step towards the advancement of the on-grid RE market. As a first of its

kind, the project would chart the path for licensing, landowner compensation, and environmental impact assessments (EIAs) for future IPPs. SREP and MDB support is desired to help bring an initial utility-scale RE project to financial closure.

A 20 MW solar PV project the DoE is procuring through a competitive bidding process has been identified as the best option where SREP funds could help this milestone be reached within the next 18 months. The DoE ran a competitive tender for the project in 2016 and currently has a preferred bidder that is in the process of negotiating with LEC. While other projects<sup>88</sup> were considered as possibilities for receiving SREP support this 20 MW solar PV project is the only one that meets AfDB's (the MDB co-sponsor) criteria to fund competitively procured projects.

A mix of SREP and AfDB funds will be used to ensure this project successfully achieves financial closure. The exact financial instrument to be used to support the transaction is yet to be determined but can be one of two options: concessional financing through the AfDB private sector window or a PRG to guard against off-take defaults on the part of LEC.

### **Technical assistance to develop an RE integration study**

The addition of wind, solar, and small hydro plants pose several new operational challenges for LEC. Before the FiT scheme is implemented, the GoL recognizes that it needs to demonstrate to investors that LEC can accept the additional intermittent load. This requires identifying the transmission investments that will be needed to support the integration of new RE capacity into the national grid. SREP support would be used to help the GoL prepare a study on RE integration. The study will develop operational procedures and identify investments that will support load balancing.

### **Solar PV site specific studies**

In parallel with the implementation of the FiT scheme, AfDB will support site specific studies for solar PV projects. These studies will aim to attract initial FiT investors by removing the costs and risks related to conducting site specific studies.

#### **7.1.2 Complementary activities**

The SREP funded activities will complement other ongoing donor programs.

### **RE resource mapping exercise**

Another missing piece in the enabling framework for RE development in Lesotho has been the absence of an RE resource atlas that identifies potential project sites by resource type. The on-grid RE component will be complemented by a resource mapping study that is being funded by the Government of Italy.<sup>89</sup> The study will lower project preparation costs for potential developers by eliminating the need to conduct preliminary site assessments. [Preliminary resource maps by September 2018]

### **Advisory support to enable adoption of FiT framework**

---

<sup>88</sup> For example, the 35 MW Letseng Wind Farm and 20 MW Solar PV project in Maseru were considered.

<sup>89</sup> Italian Ministry of the Environment, Land and Sea

In support of the on-grid RE component, DoE and the GoL will adopt the FiT rules proposed in the RE regulatory framework prepared for LEWA.<sup>90</sup> The FiT framework will be used for the procurement of solar PV and wind projects (30 kW and less than 50 MW) and small hydro projects less than 10 MW. The EU, as part of its ongoing capacity building program with DoE, will provide technical support to DoE staff to assist with adoption of the framework, determination of the tariff levels by technology, and release of a public announcement. The GoL intends to adopt the FiT framework in 2018.

### **7.1.3 Overview of priority activities**

- Investment in a 20 MW solar PV project
- RE Integration Study
- Site specific studies for a solar PV project

## **7.2 Component 2: Distributed RE Solutions**

Nearly two-thirds of Basotho do not have access to electricity and rely mostly on biomass to meet their energy needs. The reliance on biomass has detrimental health, economic, and ecological effects. The GoL views improving access to modern energy services as a necessary step to improving lives and increasing economic opportunities. Microgrids are viewed as the preferred option for delivering electricity service to off-grid households clustered closely together. For the people who live outside areas with microgrid potential, other distributed RE technologies will be needed to reduce reliance on biomass. While SHS is the closest equivalent to on-grid electricity, other options such as the powerhub stoves being made in Lesotho, improved cookstoves, solar water pumps, and solar water heaters also provide various health and social benefits that can still reduce biomass dependence and meet basic energy needs.

Both UNDP-GEF and the EU have ongoing pilot projects for both microgrid and RE business centre schemes. The Distributed Energy Solutions project will aim to build off the lessons learned from these pilots and seek to expand electricity access by scaling-up the most successful pilots. First, SREP funds will be used to fund a study to identify which scheme is appropriate for each off-grid area. Then, based on the results both SREP and MDB funds will be used to support investments in microgrids and other distributed RE (via business centres).

### **7.2.1 SREP supported activities**

The SREP funded portion of this project consists of financing support for microgrids and other distributed RE technologies. The World Bank will implement the activities under the off-grid component. The World Bank was selected to co-sponsor this component because the intended outcomes align with an on ongoing effort at the World Bank to focus on improving access to energy. For example, projects in Kenya and Zambia are both testing the effectiveness of various business models for attracting private sector investment to off-grid areas. It was viewed there is a potential

---

<sup>90</sup> The FiT rules specify that tariffs and installation targets will be set separately for each technology. FiTs will be calculated using the methodology defined in the rules and operators delivering energy to the grid will receive the tariff for 20 years. All operators that deliver energy to the grid from an eligible RE project will need to obtain a license from LEWA (application and procedures have already been adopted) and sign a PPA with LEC (a PPA template has already been prepared in the RE Regulatory Framework).

to eventually bring the lessons learned from these and other World Bank projects into the project preparation of the off-grid activities in Lesotho. The implementation institution cannot be definitively identified at this time due to potential reorganization of off-grid responsibilities.<sup>91</sup> The World Bank will evaluate the status of this process and identify who the best institution is for this component at the time of project appraisal.

### **Investment in Microgrids**

The microgrid pilot projects to come out of the UNDP-GEF and EU projects are the initial stage in development of a private sector microgrid market. The pilots implemented from these projects will provide lessons on technical and financial operations of private microgrid systems will inform subsequent investors. With the support of SREP, the next stage in development of the off-grid RE market will be to scale-up microgrid investments by establishing a competitive bidding process.

The GoL's plan to attract private sector microgrid developers is to implement a system of area-based concessions. The Electricity Masterplan will identify which areas will be tendered for microgrid concessions. The DoE and REU will run the tenders per the tender rules specified in the RE regulatory framework. A draft set of tender rules, licensing procedures, technical standards, an off-taker PPA<sup>92</sup>, and an implementation agreement have already been developed as part of LEWA's RE regulatory framework. Private developers will bid own and operate microgrids in specified areas and sell service directly to rural customers, just like a typical distribution company. Consumers would pay the same price paid by customers of LEC, with the gap in recovery being covered through a levy charged to all electricity customers.

SREP funds would be used to support an initial round of tenders to procure microgrid concessionaires. SREP funds could be made available in the form of grants or loans to lower the subsidy required in the first round of tenders. If the tariff for a specific zone are found to be too high or well outside prices being offered in other zones then a blend of SREP and World Bank funds could be on-lent to the developer at more concessional rates, through the Ministry of Finance, to buy-down the tariff. The intention of using SREP funds to support these initial tenders would be to increase developer interest with the aim of attracting highly qualified bidders with a track record of successfully operating other microgrids in order to avoid the maintenance problems that have occurred in Lesotho, and other parts of Africa.

### **Investment in other distributed RE**

Establishment of local energy business centres is viewed by many stakeholders as the most realistic option for bringing RE technologies to the dispersed areas where microgrids are not viable options. This project will look to build off the lessons learned from the EU and UNDP-GEF initiatives. Once these initial business centres have demonstrated the potential of the model, one area of interest is making it easier for RE vendors and their customers to gain access to capital. There is currently no local financial institution that offers RE financial products. SREP funding could be used to

---

<sup>91</sup> The EU capacity building program has recommended that the REU, currently under the DoE, be separated into its own independent institution.

<sup>92</sup> Off-taker agreement with LEC is for compensation when/if national grid encroaches microgrid service area.

solve this problem. An option being considered is the development of a green financing facility at a local bank. One of the advantages of a financing facility approach is that it can be technology agnostic and would allow consumers to decide what technology is best for them. The technologies supported under this activity, therefore, could go beyond SHS and ICS devices to include solar irrigation, solar water pumps, and solar water heaters. The exact set of technologies the financing facility would offer products for would be determined at the time of project preparation based on discussion with the DoE and results from pilot projects.

The preliminary plan for this approach is for SREP and World Bank funds to be sent to a local bank for on-lending to RE developers, vendors, and possibly even individual commercial or residential borrowers. As part of project preparation, the World Bank will evaluate the capacity of the local financial institutions to provide RE financial products. Additional donor support could also be used to provide training to local bank staff on different RE financial products, how to critically evaluate RE projects, and how to ensure the bank and their borrowers comply with MDB environmental and social impact requirements. Other support could be provided to the local bank to develop an education or marketing campaign to help promote the new facility. The goal would be to help develop a self-sustaining financing facility that will support investments in distributed RE well beyond the time frame envisioned for SREP investments.

### **Small Hydropower plants (SHPP) Technical Support**

The GoL has made it a priority to develop sufficient domestic generation capacity to meet the country's electricity demand. While the solar PV projects to be supported in Component 1 will contribute to the reduction of energy imports during the hours of the day when demand is highest, it cannot be relied on as base load supply. Hydropower is viewed to be the best option for providing a consistent, reliable source of power for achieving this goal and one that is complimentary to the solar PV activities that would be supported by SREP in Component 1. A significant challenge facing development of SHPPs has been a lack of data on potential sites. The resource mapping study underway will provide a preliminary assessment of areas where there is hydropower potential, but additional in-depth information will be needed to determine the exact potential of individual sites. Compared to wind and solar, these in-depth assessments of hydropower sites can take up to twice as long, and can be up to five times more expensive. There is concern that the combination of the prohibitive costs of these studies as well as the challenges and associated risk of being the first developers of private SHPPs will act as barrier specific to the SHPP investors.

The SHPP Technical Support will aim to overcome this barrier by using SREP funds to conduct pre-feasibility studies of HPP sites among the most promising ones identified in the mapping study.<sup>93</sup> The results of the studies will be made available to potential developers and procured either through the FiT scheme (if the sites identified are 10 MW or below) or a reverse auction competitive tender<sup>94</sup> (if over 10 MW).

---

<sup>93</sup> The intention is to conduct studies on sites that are within the range of small HPPs used in this IP (less than 10 MW), but should sites with slightly more than 10 MW potential be identified as being among the best then it is desired to have flexibility to study these sites as well.

<sup>94</sup> A reverse auction is a lowest tariff base procurement approach.

The World Bank would help conducting this technical assistance, given that they are already providing technical assistance (TA) to LHDA to identify potential medium and large HPP sites, it was viewed that this SHPP TA is a natural extension of that activity.

### **7.2.2 Complementary activities**

The SREP funded off-grid activities will also complement other ongoing donor programs.

#### **Electrification Masterplan**

As part of the EU's ongoing capacity building program with the DoE it is funding the preparation of an electrification masterplan to guide sector planning, and formally establish what areas are destined for grid extension. The masterplan will define the areas that will be served by the grid and the areas that will require decentralized services. The masterplan will also define the roles and responsibilities for DoE, REU, LEC, and the private sector, to enable improved coordination as electrification investments increase.

#### **Pilot off-grid RE programs**

As mentioned above, both the EU and UNDP-GEF are financing separate RE pilot programs in off-grid areas. The use of both grants (EU) and performance-based incentives (UNDP-GEF) will be helpful in determining how best to use SREP and MDB funds to support the microgrid and business centre schemes.

### **7.2.3 Summary of off-grid RE activities**

- Investment in microgrids
- Investment in SHS or other stand-alone systems
- Technical assistance for preparation of microgrid tenders.

## **7.3 Environmental and Social Co-Benefits**

The technologies included in this IP all have environmental and social co-benefits. Many of these benefits are the same across the RE technologies, but each technology also has its own unique benefits to be considered. Sections 7.3.1 to 7.3.5 describe some of the benefits related to these technologies.

### **7.3.1 Employment benefits**

- A mix of utility-scale and off-grid technologies offers tailored solutions that can increase access to electricity in urban centres and in remote villages. Electrification can create jobs in construction and electrical appliance manufacturing and retailing, as well as sustain general business activities.
- Off-grid technologies have the best potential for increasing access to electricity for remote areas where expansion of the grid network is not viable. Increased access to electricity can help these communities grow by facilitating income-generating activities.
- Lesotho can diversify its economy by developing a previously non-existent wind energy industry.

- Investment in solar PV can build Lesotho's skill base by supporting community training institutions such as the Bethel Business and Community Development Centre.

### **7.3.2 Social services and infrastructure benefits**

- Increased access to electricity can make it easier to provide social services.
- RE technologies can improve the reliability and quality of electricity, improving service delivery at schools and clinics, leading to better health and educational outcomes.
- Utility-scale technologies require the most investment in transport infrastructure, thus the population can benefit from improved road networks.

### **7.3.3 Natural resource management and land use benefits**

- Better access to modern energy services through electrification and distributed technologies can mitigate Lesotho's over-exploitation of biomass resources.
- Unlike fossil fuel and hydropower plants, solar PV will not require a lot of water for operation.
- For microgrids, the potential sites in Lesotho that were proposed by OnePower have one unique environmental opportunity: The projects propose planting a perimeter of indigenous trees and grass around the power plant to reforest the area, reduce soil erosion, and create grazing grounds for livestock.

### **7.3.4 Climate change effects and local air pollution benefits**

- Lesotho is vulnerable to climate change, which could increase the risk of droughts, flooding, land degradation, and loss of biodiversity. Adopting RE technologies results in lower greenhouse gas emissions compared to fossil fuel-based electricity imports on which Lesotho relies.
- Rural households are reliant on paraffin and biomass for energy; off-grid solutions provide an environmentally friendly alternative to these traditional fuels.
- Clean cook stoves eliminate noxious fumes that impact residents' health, particularly the vulnerable, such as children.

### **7.3.5 Financial and time-saving benefits**

- Extra power could potentially be exported to the Southern African Development Community (SADC), providing revenue for the economy.
- Recent technological progress has made solar PVs more efficient and cheaper to construct.
- Clean cook stoves allow women and children to spend less time collecting biomass.
- Clean cook stoves are portable, allowing for shared use.



## **7.4 Environmental and Social Risks**

The technologies included in this IP all have environmental and social risks. Many of these risks are the same across the RE technologies, but each technology also has its own unique risks to be considered. Sections 7.4.1 to 7.4.4 describe some of the risks related to these technologies.

### **7.4.1 Pollution risks**

- RE development may result in pollution from construction and operations. The effects of pollution may be critical in protected areas, such as FEPAs.
- Chemicals involved in utility-scale solar PV or solar microgrids, such as arsenic and cadmium, may be used during construction and may be harmful to local animal and human populations if not properly disposed. Distributed solar technologies also require the handling of hazardous chemicals for construction that could endanger the local area if exposed.

### **7.4.2 Biodiversity conservation, and land use risks**

- RE site construction has the potential to impact some of the 377 animal species (of which 14 are Endangered and Vulnerable) and 98 plant species (of which four are Endangered and Vulnerable) on the International Union for Conservation of Nature Red List of Threatened Species for Lesotho.
- Certain projects such as the Letseng wind farm have raised concerns that they could threaten endangered Cape and Bearded Vulture species.
- Some utility-scale solar PV sites may compete with existing agricultural or ecologically protected land, or reduce the availability of land for alternate uses.

### **7.4.3 Noise pollution and other disturbance risks**

- Solar PVs can cause glare for birds or airplanes, affecting flight paths. However, effects on airplanes may not be a likely risk for solar microgrids given that the existing microgrid at the Moshoeshoe I International Airport has not yet presented any problems.

### **7.4.4 Financial and effectiveness risks**

- Uptake of clean cook stoves may be slow because they are expensive. Equity concerns may occur if the poorest are unable to afford clean cook stoves, as they may be most affected by indoor air pollution.
- Clean cook stoves may not reduce biomass dependency substantially since they cannot provide the same level of heating as traditional stoves.

## 8 Financing Plan and Instruments

Table 8.1 presents a plan for financing the projects described in Section 7. It shows the proposed credits and grants from SREP as well as estimates of the amounts anticipated from MDBs, Government, other donors, and the private sector.

As the table shows, US\$ 18.50 million of SREP funding is expected to catalyze over three times as much investment, most of it from the private sector (as equity or debt), and the MDB co-sponsors. These funds will be used to build off the more than US\$ 7 million in funds already committed by the EU, UNDP-GEF, and Government of Italy to develop parts of the enabling framework and pilot projects that are laying a strong foundation for SREP funded projects.

The exact financing modalities will be determined at the time of appraisal, but it is expected that:

- US\$5 million of SREP funding, in the form of a concessional loan, would be used to leverage US\$11.5 million in grants and private concessional loans (or a PRG) from AfDB, US\$7.5 million in equity contributed from the developers of a 20 MW solar PV project, and US\$6.9 million in additional financing from either a private lender or other DFI.
- US\$12 million of SREP funding (US\$4 million in grants, US\$8 million in concessional financing) would be used to leverage US\$ 10 million in financing from the World Bank, and US\$20 million in investment from other private sector investors in microgrids and other distributed RE technologies. These funds will be complemented by another US\$4.8 million from other donors.
- US\$1.5 million in SREP grants would be used for: an AfDB managed RE integration study (US\$0.6 million); and World Bank managed site specific pre-feasibility studies (US\$0.9 million). The studies to support the development of an enabling environment will be complemented by another donor grant (US\$1.4 million) for an RE mapping study.

The GoL will contribute by facilitating fiscal incentives for services associated with the financing plan. These incentives will possibly include: waiving corporate profit tax for the first 10 years of operation and excluding RE technology sales from VAT.

**Table 8.1: Lesotho SREP IP Financing Plan**

SREP Project	SREP	WB	AfDB Private Window	AfDB	Government of Lesotho	Other DFIs	Private Sector / Sponsor Equity	Total
<b>On-Grid RE</b>								
Investment in Utility-Scale Solar PV Plant	5		10 <sup>i</sup>		0.6	TBD <sup>ii</sup>	14.4 <sup>iii</sup>	30
RE Integration Study	0.6							0.6
Resource mapping study						1.4 <sup>iv</sup>		
Project Implementation Support + Site Studies				1.5 <sup>ii</sup>				
<i>Subtotal: On-Grid RE</i>								
<b>Distributed RE Solutions</b>								
Investment in microgrids	4	4			1.8	2.6 <sup>v</sup>	5	4
Investment in distributed RE technologies	0.9							0.9
	12.9	10			5.9	5.8	20	12.9
<i>Subtotal: Distributed RE Solutions</i>		4.68						
<b>Grand Total:</b>					1.5 <sup>ii</sup>			
<b>SREP Leverage</b>	5.6							

Note: i) Financing instrument/AfDB window has yet to be determined. Two options being considered are to provide direct project financing through the AfDB private sector window or use an AfDB PRG to attract other private sector or DFI financing; ii) Project implementation support and site studies will be funded through a grant from the AfDB managed SEFA fund. iii) Total private sector contributions include sponsor equity (US\$7.5 million). The remaining US\$6.9 million could come from a private financial institution or DFI; iv) Government of Italy; v) EU US\$2.3 million + UNDP-GEF US\$0.9 million; vi) EU US\$2.3 million + UNDP-GEF US\$0.3 million;

## 9 Responsiveness to SREP Criteria

The IP developed for Lesotho is responsive to all of the SREP criteria. Table 9.1 summarises how each project responds to the SREP criteria.

**Table 9.1: Summary of Proposed Projects' Responsiveness to SREP Criteria**

Criteria	On-Grid RE Project	Distributed RE Solutions Project
<b>SREP Criteria</b>		
Increased installed capacity from RE	SREP resources would be used to finance the development of a 20 MW solar PV plant, the first commercial utility-scale plant in Lesotho.	<ul style="list-style-type: none"> <li>▪ SREP resources would be used to finance the development of 9 MW of solar PV-battery hybrid microgrids through an off-grid concession scheme.</li> <li>▪ SREP resources would be used to finance the development of 0.77 MW of SHS, other solar technologies, and improved cookstoves.</li> <li>▪ SREP resources would be used to finance an in-depth study to assess the economically feasible potential of small hydro in Lesotho.</li> </ul>
Increased access to energy through RE	The utility-scale RE project indirectly supports electrification because new supply potentially enables more connections.	<ul style="list-style-type: none"> <li>▪ Microgrids have high potential to directly provide electricity access to households.</li> <li>▪ SHS directly provides electricity access to households.</li> </ul>
Lower emissions	The technologies included under the utility-scale RE project produce no GHG emissions.	<ul style="list-style-type: none"> <li>▪ Microgrids produce no GHG emissions.</li> <li>▪ SHS and other solar technologies produce no GHG emissions. Improved cookstoves substantially reduce GHG output, but not all stoves eliminate emissions completely.</li> <li>▪ Power generation from small hydro does not produce any GHG.</li> </ul>

Criteria	On-Grid RE Project	Distributed RE Solutions Project
Affordability & competitiveness	<p>Utility-scale solar is competitive with imported energy under both financing scenarios. Only the best utility-scale wind resources are competitive with imports under private financing; other sites require subsidies. Small HPPs require a small subsidy to be competitive with imports.</p>	<ul style="list-style-type: none"> <li>▪ Microgrids are competitive with diesel generators, but the cost might still be too high for rural customers.</li> <li>▪ Improved cookstoves pay for themselves within a few months because of offset fuel costs. SHS needs subsidies to be affordable. Solar pumps are competitive with diesel pumps, but it is unclear if other solar technologies are also competitive.</li> <li>▪ The results of the feasibility study may identify hydro sites that have a lower LCOE than other RE technologies.</li> </ul>
Productive use of energy	<p>Utility-scale RE technologies provide firm baseload power.</p>	<ul style="list-style-type: none"> <li>▪ Micro-girds provide reliable firm power for productive uses.</li> <li>▪ SHS provides power sufficient for operation of lights and small appliances. Other solar technologies provide power for specific productive purposes, such as improved agricultural yields. Improved cookstoves are only for personal use, but indirectly increase productivity by reducing time spent on collecting fuel.</li> <li>▪ The results of the feasibility study may identify hydro sites that can provide firm baseload power, providing more reliable power supply for productive uses.</li> </ul>

Criteria	On-Grid RE Project	Distributed RE Solutions Project
Economic, environmental, and social impact	<p>(+) These technologies offset imports of coal power.</p> <p>(-) Land used for solar competes with agriculture.</p>	<p>(+) Microgrids can improve off-grid economic activity.</p> <p>(+) Microgrids provide in-home lighting.</p> <p>(-) Batteries need to be disposed of properly.</p> <p>(+) SHS provides in-home lighting and can improve off-grid economic activity.</p> <p>(+) Other solar technologies can create local jobs, improve health and safety, and improve agricultural yields.</p> <p>(+) Improves cookstoves reduce GHG emissions and have health, social, and deforestation benefits.</p> <p>(-) SHS batteries need to be disposed of properly.</p> <p>(+) Small hydro generation would offset power imports generated from coal.</p> <p>(+) Small hydro could provide local flood protection and irrigation if properly designed.</p> <p>(-) Some potential sites may be in Strategic Water Source Areas, which are sources of Lesotho's and South Africa's important water sources. Sites that deteriorate the quality and quantity of water would have cumulative impacts downstream.</p> <p>(-) Sites may be vulnerable to extreme weather impacting the reliability of generation in the case of droughts or flooding.</p> <p>(-) Sites may damage nearby ecosystems and farms from the displacement of water or entrapment of river species inside the generation plants.</p>

Criteria	On-Grid RE Project	Distributed RE Solutions Project
Economic and financial viability	<p>Utility-scale solar is economically and financially viable now. Wind is economically viable, but only financially viable with subsidies. The economic viability of small HPPs is site specific; small HPPs require subsidies to be financially viable.</p>	<ul style="list-style-type: none"> <li>▪ Microgrids are economically and financially viable now, compared to off-grid diesel.</li> <li>▪ Improved cookstoves are economically and financially viable if investment is financed. Solar pumps are both economically and financially viable, but the viability of other solar technologies is unclear. SHS has low viability compared to diesel generators.</li> <li>▪ Supply curves shown in section 5 show that SHPPs are theoretically lower cost than other RE technologies such as waste-to-energy or wind. Because SHPP is site specific, a feasibility study confirming the technical, economic, and financial viability of the technology will offer Lesotho authorities an critical advantage for preparation of partnerships with potential sponsors.</li> </ul>
Leverage	<p>Investments from the private sector, MDBs, and government are estimated to leverage 4.7 times the amount contributed by SREP.</p>	<p>Investments from the private sector, MDBs, and government are estimated to leverage 3.4 times the amount contributed by SREP.</p>
Gender	<p>The utility-scale RE project has the potential to create jobs and/or increase economic activity, thereby improving the lives of women.</p>	<ul style="list-style-type: none"> <li>▪ Microgrids mostly benefit households and women by reducing the burden of collecting and purchasing fuel.</li> <li>▪ SHS and improved cookstoves both reduce the burden of purchasing and collecting fuel, which largely falls on women. Solar streetlights improve safety while solar pumps reduce collection times for water.</li> </ul>

Criteria	On-Grid RE Project	Distributed RE Solutions Project
Co-benefits	The utility-scale RE project may result in multi-year construction jobs as well as long-term jobs.	<ul style="list-style-type: none"> <li>▪ Microgrids enable increased economic activity in off-grid villages and reduces dependence on more costly energy sources.</li> <li>▪ SHS increases household safety and extends study hours for students. Other solar technologies can improve public safety, crop yields, and access to clean water. Improved cookstoves support forest conservation goals and improve household air quality.</li> <li>▪ SHPP designed to provide irrigation to farms can improve agricultural yields.</li> </ul>
<b>Additional National Criteria</b>		
Job creation	The utility-scale RE project may result in multi-year construction jobs as well as long-term jobs.	<ul style="list-style-type: none"> <li>▪ The microgrid project will provide opportunities for jobs as vendors and technicians.</li> <li>▪ The distributed generation project will create supply chain, domestic manufacturing, vendor, and technician jobs. Other solar technologies may also enable improvements of existing jobs.</li> <li>▪ Since Lesotho has existing SHPPs, additional development may result in higher utilization of local labor for operation and maintenance.</li> </ul>
Ensures energy security	Output from 20 MW solar PV plant will be delivered during daily peak hours when imports are typically needed, thus contributing to GoL goal of reducing reliance on imports.	<ul style="list-style-type: none"> <li>▪ The microgrid project will provide high quality, reliable power in off-grid areas.</li> <li>▪ SHS has sufficient power to meet households needs in off-grid areas. Improved cookstoves reduce the need for fuel imports.</li> <li>▪ Identified hydro sites may have relatively higher capacity factors than other RE options that can help the GoL meet base load with domestic supply.</li> </ul>



Criteria	On-Grid RE Project	Distributed RE Solutions Project
Promote private sector involvement in energy	The demonstrative impact of the utility-scale project can increase PSP.	<ul style="list-style-type: none"> <li>▪ The demonstrative impact of the microgrid project can increase PSP.</li> <li>▪ The availability of detailed resource data may increase private sector willingness to invest in small hydro in Lesotho.</li> </ul>

## 10 Implementation Potential with Risk Assessment

The implementation risk of the IP in Lesotho is moderate. Table 10.1 summarizes key risks that can impact the implementation of projects under the SREP Programme in Lesotho.

**Table 10.1: Risk Assessment of the SREP Programme in Lesotho**

Risk category	Description	Mitigation measure	Residual risk
Legal and regulatory	Incomplete (not adopted) legal and regulatory framework for RE creates an uncertain investment climate for potential project sponsors	Energy Act and RE regulatory framework need to be adopted	Moderate
Institutional and capacity	Overlapping institutional mandates slows down the implementation of projects causing private sector to lose interest	Adopt mandate revisions proposed by the energy sector reform study being conducted by the EU	Moderate
	Outdated/inaccurate energy baseline and resource data	The Government of Italy is supporting the GoL to develop RE resource maps and UNDP is supporting a national energy baseline survey. Results of the survey will be harmonized national energy policy and climate change strategies	Moderate
	Energy sector entities have limited experience coordinating and implementing RE projects outside of hydropower and high turnover of staff	MDBs to carefully identify capacity of institutions at time of project appraisal and identify training and TA activities need to enable energy sector entities to manage, coordinate, and implement RE projects	High
Technology specific	Technical specifications of proposed projects are not optimized	MDBs will support the preparation of project feasibility studies to ensure that they meet the highest technical specifications	Low
	Distributed technologies are poorly installed and maintained	Provide training to local technicians to ensure equipment is installed and maintained to highest standards	Moderate

		Provide training to target users on proper use and maintenance of technology.	
Financial	Access to commercial financing for Project sponsors is limited	Provide concessional financing to improve the financial viability of Projects Provide training to financial institutions on appraising RE projects	Low
	Risk of off-taker default or arrears	Provide loan or payment guarantees to reduce Project sponsor credit risk	
	Customers unable and or unwilling to pay for electricity	Conduct willingness to pay and affordability studies to inform the development of subsidies and targeted social protection schemes for low income customers	Moderate
Environmental	RE projects may negatively impact surrounding areas during construction or operations (noise pollution, land use changes, chemical and other pollutant discharge)	Each RE project will undergo MDB approved environmental assessments and due diligence processes to ensure environmental risks are addressed	Low
Social	RE projects may have unintended social impacts during construction or operations (foreign or migrant worker inflow, power dynamics among local population)	Each RE project will undergo MDB approved social assessments and due diligence processes to ensure social risks are addressed	Low

# 11 Monitoring and Evaluation

The investments proposed in this IP can have a transformative impact on Lesotho’s energy sector. Utility-scale investments can help the country diversify and increase its generation capacity to meet future demand and reduce its dependence on expensive electricity imports. Investments in microgrids and distributed technologies can accelerate electrification and energy access in rural areas, improving the quality of life and livelihoods of the population.

An M&E system will be established by the Government, in cooperation with MDBs and other donor partners to track and report the Programme’s progress towards achieving its objectives. The M&E framework will be coordinated by the Renewable Energy Division of the DoE. MDBs and other development partners such as the UNDP have pledged to provide the Renewable Energy Division with support and training to facilitate data collection, analysis, and reporting for SREP IP M&E framework. Table 11.1 describes the proposed M&E framework for the Lesotho SREP IP.

**Table 11.1: Lesotho SREP Investment Plan Results Framework**

Result	Indicators	Baseline	Targets	Means of Verification
<b>SREP Transformative impact indicators</b>				
<b>Support low carbon development pathways by reducing energy poverty and/or increasing energy security</b>	Percentage of total households with access to electricity <sup>95</sup>	38% (2016)	75% (2022)	National M&E (Census data)
	Percentage of rural households with access to electricity <sup>96</sup>	18% (2016)	75% (2022)	IPPs and DoE
	Annual electricity output from RE <sup>97</sup>	54%	65% (2020)	DoE and IPPs
	Avoided CO <sub>2</sub> emissions (tons/year)	0	125,000 t CO <sub>2</sub>	DoE
<b>SREP outcomes</b>				
<b>Increased supply of renewable energy</b>	Increased annual electricity output (GWh) as a result of SREP interventions	0	91.5 GWh, including 61.5 GWh from the 20 MW solar PV plant (on-grid RE project) and 30 GWh from the	DoE, LEC, IPPs

<sup>95</sup> The Revised SREP results framework (2012) says that this indicator should be a “National measure of ‘energy poverty’ such as the Multi-dimensional Energy Poverty Index (MEPI), or some equivalent mutually agreed measure.” Energy poverty is indeed a multi-dimensional problem which includes problems associated with a lack of access to sufficient energy supply, a lack of access to clean energy, and a lack of access to affordable energy.

<sup>96</sup> A household is considered to have access to electricity when the service provided allows for charging of cell phones and lighting at night.

<sup>97</sup> Assumes that all domestic electricity production is renewable and all imports are non-renewable.

			technologies in the Distributed RE Solutions project	
<b>Increased access to modern energy services</b>	Number of women and men, businesses and community services benefitting from improved access to electricity and fuels as a result of SREP interventions	0	32,500 men  32,500 women  500 SMES & Community services	Project M&E
<b>New and additional resources for RE projects</b>	Leverage factor: US\$ financing from other sources compared to SREP funding	0	3.53	DoE
<b>Volume of private sector finance in RE</b>	Total private RE financing in US\$ from private sector	0	US\$ 34.4 million	DoE

# Appendix A: Project Concept Briefs

## A.1 On-Grid RE Technologies

### Problem statement

1. Lesotho has abundant RE potential but relies heavily on expensive electricity imports from South Africa and Mozambique to meet demand. In 2016, Lesotho imported 36 percent of its electricity needs, of which, 55 percent was used to meet peak demand. Because Lesotho has a similar load profile to South Africa and Mozambique, imports to meet peak demand are especially expensive. In 2016, the price of imported electricity ranged from M 0.77 to M 1.50 per kWh, at least 83 percent more expensive than the cost of electricity (M 0.13/kWh) purchased from the country's MHP. In addition, because Lesotho pegs its currency to the South African Rand, purchasing Rand or US dollar denominated electricity imports puts depreciation pressure on the Maloti, increasing the cost of all imported goods in the long run.
2. The private sector recognizes the potential for Lesotho's electricity supply gap to be met by RE generation and has expressed substantial interest in developing utility-scale solar facilities. Several projects have been proposed and developed to various stages, but none have been implemented. In 2015, with the support of AfDB, LEWA drafted a regulatory framework for the development of RE resources in Lesotho. The draft PPA template developed by the project has been published by on LEWA's website to guide LEC and potential power producers who are interested in entering into a bilateral contract. As of June 2017, negotiations for the first commercial utility-scale solar facility is underway. However, additional steps need to be taken to ensure that the project achieves financial closure and RE integration to the grid is sustainable.

### Project objective

3. The Project objective is to increase the diversity and reliability of electricity supply in Lesotho. The Project's objective will be achieved through (a) investments of 20MW of utility-scale solar to offset expensive and Rand denominated electricity imports from South Africa; (b) technical assistance to create an enabling environment for on-grid renewable integration and investments in utility-scale solar. The Project will include three components:
  - **Component 1: Investments in utility-scale solar.** SREP contributions would be used to leverage additional African Development Fund and private sector financing to achieve financial closure. Two options will be considered for financing the investment: (a) mobilizing concessional private sector financing for the debt portion from the AfDB private sector windows and other DFI; or (b) the AfDB would offer PRG ) to guard against off-take defaults on the part of LEC and de-risk debt financing if required by private sector.
  - **Component 2: Study on renewable integration to the grid.** The introduction of intermittent RE generation such as wind and solar increases variability and

unpredictability to the grid. AfDB will commission a study on RE integration to the grid to develop operational procedures and identify investments that will support load balancing for the power system operator.

- **Component 3: Technical assistance for project preparation and solar PV site studies.** SEFA and Africa Climate Technology Center funds will be used to support project preparation activities required for the PPA to reach bankability and proposed project to reach financial close. Components under the SEFA Project Preparation Grant (PPG) comprise Technical and Financial Services, Environmental and Social Impact Assessment (ESIA) and Lenders' Due Diligence & Risk Allocation. AfDB will support the best possible structuring of the project and strive to turn it into a replicable solar PV reference for the SADC Region. In addition, AfDB will look to support the next solar PV projects by funding up to two pre-feasibility studies of solar PV sites that are identified in the resource mapping study that will be complete in 2018.

#### **Proposed contribution to initiating transformation**

4. The proposed investment component of this Project will contribute to the GoL's Vision 2020 strategy to increase the use of RE by 200MW by 2020 and reduce the country's reliance on imports to meet peak demand. Because the investment is for the first commercial IPP in Lesotho, it may have a demonstration effect on the RE sector by signaling to potential investors that the business environment for RE is commercially viable and showing the necessary steps required to initiate RE investment. The technical assistance provided under this project improves the enabling environment for RE integration to the grid by identifying investments to improve grid reliability as intermittent generation is introduced, and developing the necessary processes for load balancing.

#### **Implementation readiness**

5. The MEM is in the process of completing a competitive tender for a 20 MW solar PV project. The project has secured a government buy-in and authorization, and the preferred bidder is currently in PPA negotiations with off-taker LEC (June 2017). A PPA is expected to be signed in the third quarter of 2017.
6. The project is the first potential PPA to reach the advanced PPA negotiation stage. SREP funds together with AfDB contributions will be used to mitigate the risk of off-taker default, ensure successful financial closure, and prepare the grid for integrating solar generation.

#### **Environmental and social impact mitigation plan**

7. An EIA has been conducted and cleared by the Department of Environment. Additionally, an environmental and social management framework, consistent with the requirements of the AfDB, will be developed as part of project preparation. The SEFA PPG will cover the costs for a full ESIA to build upon the existing environmental clearance granted by Department of Environment of the Ministry of Tourism, Environment and Culture.

## Rationale for SREP financing

8. SREP financing will create an enabling environment for RE by supporting a study to understand how to integrate safely and efficiently integrate RE generation in Lesotho’s grid beyond the proposed project. SREP financing for this project will leverage AfDB funds, which will be used to mitigate against perceived off-taker and country risk to facilitate financial closure of the transaction. SREP financing to support the financial closure of the proposed project – the first commercial IPP in Lesotho – will also serve as a demonstration effect to the private sector by signaling the viability of RE technologies in the country, and the readiness of the GoL and regulatory regime to support additional investments.

## Results indicators

9. The expected outcomes of the project include the following:
- 20MW of utility-scale solar generation capacity installed;
  - Increased supply of electricity generated from RE;
  - Private sector investment leveraged;
  - Site studies for new solar PV projects;
  - Increased government and private sector experience and capacity to develop large-scale RE projects; and
  - GHG emissions reduced or avoided<sup>98</sup>.
10. Results indicators will be determined during the project preparation stage.

## Financing plan

Components	Sponsor Equity	Private sector	Other DFI	SREP	ADF/ PRG	AfDB private sector window	Govt.	SEFA and ACTC grant	Total
<b>Component 1</b>									
Option1 - PRG	7.5	6.9		5	10	NA	0.6		30
Option2 - Concessional debt	7.5		6.9	5		10	0.6		30
<b>Component 2</b>									
RE integration study				0.6					0.6
<b>Component 3</b>									
Project preparation								1.5	1.5
<b>Component 4</b>									

<sup>98</sup>



Project implementation				0.42					
------------------------	--	--	--	------	--	--	--	--	--

**Lead Implementing agencies**

11. The project will be implemented by the AfDB and selected private investor. The AfDB will consider providing a PRG to guard against off-take defaults on the part of LEC and de-risk debt financing in case they are not able to mobilize concessional financing from other DFIs. SEFA grant will support project preparation.

**Project preparation timetable**

12. The AfDB will proceed with component 2 and 3 using SREP project preparation, SEFA and ACTC grants. The AfDB intends to proceed to board presentation for the investment approval during the 4<sup>th</sup> quarter of 2018, subject to the progress of preparation activities with SEFA and ACTF grant.

**Project preparation grant**

13. The Government of Lesotho is requesting a project preparatory grant of US\$ 0.6 million to undertake RE integration study.

## A.2 Distributed RE Solutions

### PROBLEM STATEMENT

14. Access to modern energy services is important for fostering economic growth and reducing poverty. The energy sector in Lesotho faces challenges which include: low access to modern and clean energy, supply security issue due to dependence on imported electricity and fuels, and deterioration of forest reserves. The Government of Lesotho recognizes these challenges as a barrier to the country's development and has established targets to increase electricity access to 75 percent by 2022 and increase the use of RE sources by 200MW by 2020.
15. One of the sector main challenges is the low rate of household access to electricity and modern, cleaner sources of energy for lighting, heating, and cooking. Access to affordable, modern energy sources reduces poverty, fosters economic growth, improves health, and increases productivity. Nationwide, only about 38 percent of households have access to electricity. Household electrification rates are 60 percent in urban and peri-urban areas and only 18 percent in rural areas. Increased access to electricity facilitates the delivery of the basic social services, reduce inequality, thus contributes to poverty reduction.
16. Because of lack of access to electricity and modern and cleaner energy, households use paraffin and candles for lighting and wood and dung for cooking and heating. Burning these fuels inside the house may create health problems. The collection of these wood fuels can also be time-consuming for households; according to ACE's 2015 survey of 2,652 rural households in Lesotho, households spent 31 hours per month travelling for fuel, covering an average distance of 58 km.
17. The mountainous areas of the country and the low population density of remote villages are unlikely to make rural electrification using grid extension financially viable. Therefore, the Government may have to consider other alternatives such as microgrids and stand-alone systems.
18. At lower population densities, grid extension and microgrids can be challenging in terms of economic viability in the short run. For such situation, the latest generation of stand-alone technologies (for example, SHS) could be a solution to provide basic electricity service. In Lesotho, solar project is technically feasibility because of high solar irradiation. In addition, the project could build on current initiatives of some private sectors on the distribution of stand-alone systems to rural households using microfinancing mechanism.
19. **Microgrid technologies:** This would mainly be implemented in remote areas where grid expansion is not likely to happen in the next 10-15 years and would cover technologies including solar PV and/or mini-hydro less than 10MW and/or hybrid system
20. **Distributed RE technologies:** It concerns the promotion of pre-wired solar systems for lighting and cell phone charging and of energy efficient cooking stoves, solar

water pumps, solar water heating to scale-up the current approach to provision of energy services to the peri-urban and rural population.

21. **Assessment of SHPP potential sites:** Analysis of technical parameters for pre-identified small hydropower sites would substantially contribute to attract private sponsors and operators, in particular in remote areas.

#### **PROJECT OBJECTIVE**

22. The project will transform lives of rural households through increased access to energy by implementing the following three components:
23. Component 1: Microgrid technologies. Financing would be grant based/on-lent to the government; on-lent to the implementing agencies; and channelled to sponsors or end-users.
24. Component 2: Distributed RE technologies. Financing would be grant based/on-lent to the government; on-lent to the implementing agency using financing structures and models tested in the market; before being channelled to end-users.
25. Component 3: Technical assistance for project preparation of components 1 and 2, including business models; possible participation of private sector; related regulation; and other implementation capacity strengthening activities identified as being necessary to implement the procurement approaches for components 1 and 2.
26. Component 4: Technical assistance to conduct pre-feasibility studies of HPP sites among the most promising ones identified in the mapping study. The results of the studies will be made available to potential developers.

#### **PROPOSED CONTRIBUTION TO INITIATING TRANSFORMATION**

27. The Scaling-up Renewable Energy Program in Low Income Countries (SREP) financing will reduce the gap in the climate finance architecture by facilitating the development of low carbon energy technologies towards increased RE generation to improve rural energy access. Investments proposed in this project will contribute to the achievement of government's target to increase RE capacity by 200MW by 2020. The proposed off-grid project will install up to 10 MWp of microgrids (to be confirmed during project appraisal) and will contribute to the achievement of the country's electricity access target of 75% by 2022. The off-grid systems would provide about 38,000 new household connections in peri-urban and rural areas that are not identified for grid extension in the Electricity Masterplan currently in development.

#### **IMPLEMENTATION READINESS**

28. Government and NGO have implemented minigrid projects in Lesotho. Two minigrids – one diesel generation and one hydro generation– have been installed as pilots under the World Bank Utilities Sector Reform Project (2007). In addition, the UNDP and European Delegation (EU) have recently allocated funding for microgrid pilots in rural villages in the country. The UNDP is conducting pre-feasibility studies in 20 selected villages to determine the appropriate microgrid scheme for

implementation. The EU has launched call for proposals to pilot two microgrid projects in rural areas with substantial economic growth potential. There is also some private sector interest in developing small hybrid PV microgrids to serve rural populations outside of the areas served by the utility LEC. The operation of minigrids is likely to increase in the coming years.

29. Solar PV minigrids have not yet been installed in Lesotho, but there is substantial private sector and development partner interest in developing them. Solar PV minigrids, depending on their size and the types of populations they serve, are considered viable in areas with a certain population density. 25 sites for solar PV hybrid microgrids ranging from 8-109 kW have been identified by a private developer to provide electricity service to rural communities. This developer is currently working with the GoL and UNDP to commence the installation of minigrids at some of the sites.
30. The GoL already has some experience implementing SHS activities. About one percent of households (approximately 11,000) in Lesotho currently use SHS, with a total installed capacity of 61.6 kW. The REU, through a World Bank- and Global Environment Facility (GEF)-financed pilot project, distributed SHS to 300 households in the Linakaneng region in the eastern highlands. Moreover, since 2007 the LREBRE, a GoL program with assistance from UNDP and GEF, has promoted the use of RE to satisfy basic household needs like lighting, radios, and cellphone charging. The project installed 1,537 SHSs in Mokhotlong, Thaba-Tseka, and Qacha's Nek Districts over five years.
31. To implement the execution of programme support under SREP financing, a project unit will be established within the Ministry of Energy, Meteorology and Water Affairs to implement the project. This will be manned by technically competent professionals. The Government has used this approach to implement projects which are specific in nature for them to be completed within project time frame and with minimal interference from the Government. This approach would also ensure that funds allocated to projects are used more effectively and efficiently deepening transparency of budget absorption.

#### **RATIONALE FOR SREP FINANCING**

32. The World Bank strongly supports the efforts being deployed by the GoL to implement "transformational change" towards low carbon development with the use of public and private sector investments in the energy sectors. The SREP funding will help the country to significantly reduce environmental pollution, to improve climate resilience, and to reduce greenhouse gas emissions (GHG) from the use of wood fuels.
33. Climate finance will play a critical role in assisting Lesotho to build more environmentally sustainable energy system, and to meet development objectives including increased rural energy access; improved energy security and reduced poverty.

## **ENVIRONMENTAL AND SOCIAL IMPACT MITIGATION PLAN**

34. Environmental and social impacts from the installation and operation of RE minigrids are generally not substantial given the small size of the system and the type of installation. Similarly, distributed RE technologies are low impact systems.
35. The main challenges identified at the international level on the use of PV technologies are the following:
- The decommissioning of PV modules is likely to generate an environmental challenge. As a solution, an international PV industry recycling program was established in Europe in 2009 under PV CYCLE.
  - Emissions in the PV life cycle are mostly from the material extraction and production stages. The largest concern is the fluorinated GHG emissions but releases of these gases have declined because of more efficient manufacturing processes and the use of alternative substances.
  - The amount of water used in the life cycle of PV technologies is not significant since it is necessary only during manufacturing and cleaning of modules. Moreover, the impacts on water quality are minimal.
36. No social impacts or resettlement are expected

## **RESULTS INDICATORS**

37. Results indicators will be determined during the project preparation stage and will be firmed up during the project appraisal. Expected results and outcomes of the project include the following:
- Public and private sector investment leveraged
  - Countrywide deployment of off-grid PV technologies provides people, businesses and community services improved access to electricity
  - At least 9,000 households connected to proposed minigrid systems
  - At least 10 MWp of functioning off-grid PV infrastructure
  - At least 29,000 households provided with access to electricity by stand-alone SHSs or other distributed technologies
  - At least 200 water points (drinking water or irrigation) provided with access to electricity by solar pumps
  - At least 30,000 MWh/year in supply of electricity generated from RE in off-grid areas.

## FINANCING PLAN

**Appendix Table A.1: Proposed Financing Plan for Distributed RE Solutions**

	Private sector	SREP	WB	Government	Other <sup>a</sup>	Total
(Million US\$)						
1. Component 1: Investment in microgrids	15	8	6	4.1	TBD	33.1
2. Component 2: Investment in distributed RE technologies	5	4	4	1.8	TBD	14.8
<b>TOTAL</b>	<b>20.0</b>	<b>12</b>	<b>10.0</b>	<b>5.9</b>		<b>47.9</b>

## LEAD IMPLEMENTING AGENCIES

38. The implementation agencies for the microgrid component and the RE distributed technologies will be defined during project preparation. The GoL is assessing the capacity of sector institutions and agencies and will set-up the implementation arrangement.

## PROJECT PREPARATION TIMETABLE

Appendix Table A.2 below shows the proposed schedule for project preparation.

**Appendix Table A.2: Proposed Schedule**

Task	Timeline and milestones*
1. Internal approval mini-grid technologies	Q3 2017
2. Internal approval RE distributed	Q3 2017
3. SREP Sub-Committee approval of the IP	Q4 2017
4. WB tentative Board approval	Q4 2018

\*Based on World Bank's fiscal year – July 1 to June 30

## Project preparation grant

39. The Government of Lesotho is requesting a project preparatory grant of US\$ 0.9 million to undertake pre-feasibility studies for SHPP sites.

## Appendix B: Assessment of Lesotho’s Absorptive Capacity

This appendix contains an assessment of Lesotho’s ability to absorb the financing envisioned as part of the IP. It describes the macroeconomic, debt sustainability, and institutional dimensions of the country’s absorptive capacity.

### B.1 Macroeconomic Outlook

Lesotho has experienced a sustained period of economic growth. The country recovered quickly from the global financial crisis, with GDP growing at an average rate of about 4.5 percent per year between 2010 and 2014, before dipping to 1.6 percent in 2015 because of weak manufacturing and construction sectors and relatively slow economic growth in South Africa. The IMF projects GDP to grow 2.5 to 3 percent in 2016, depending on the severity of drought conditions, and to rebound to an average of about 3.5 percent growth by 2020 because of increased diamond production and the start of construction for the water transfer component of LHWP.<sup>99</sup> Appendix Table B.1 shows Lesotho’s GDP growth since 2010 and IMF projections to 2020.

**Appendix Table B.1: GDP Growth and Projected GDP Growth in Lesotho, 2010-2020**

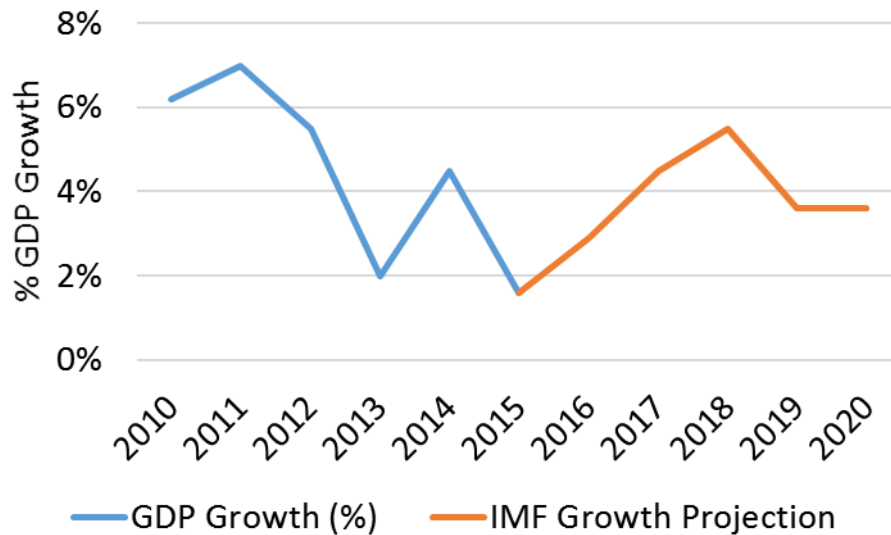

Source: World Bank Development Indicators; International Monetary Fund Country Report, 2016.

Lesotho faces several economic challenges. The broad unemployment rate, which includes discouraged workers, was 28 percent in 2015, while the youth unemployment rate (ages 15 to 24) was 43 percent.<sup>100</sup> Lesotho’s incidence of poverty is 56 percent, among the highest in Africa, and has shown little improvement over the last decade. Many health

<sup>99</sup> International Monetary Fund, “IMF Country Report No. 16/33: Kingdom of Lesotho Staff Report for the 2015 Article VI Consultation,” 2016.

<sup>100</sup> Lesotho Bureau of Statistics, “2016 Population and Housing Census: Preliminary Results Report,” 2016.

and social have likewise seen little improvement despite high rates of Government spending (about 30 percent of GDP).

The economy is also susceptible to external shocks. As mentioned above, a weak economy in neighbouring South Africa can dramatically slow growth in Lesotho. Moreover, Lesotho is particularly reliant on revenue from the Southern African Customs Union (SACU) for government financing, but these revenues are volatile and have fallen sharply from 29 percent of GDP from 2012 to 2014 to a projected 16 percent in 2017. The IMF projects that this decline in revenues will persist in the short- and medium-term.<sup>101</sup>

## B.2 Debt Sustainability

The IMF projects Lesotho's debt-to-GDP ratio to increase from about 43 percent in 2014 to 51 percent in 2016 before leveling off in the medium-term at about 47 percent, as shown in Appendix Table B.2.

**Appendix Table B.2: Lesotho's Debt-to-GDP Ratio and IMF Projections, 2012-2020**

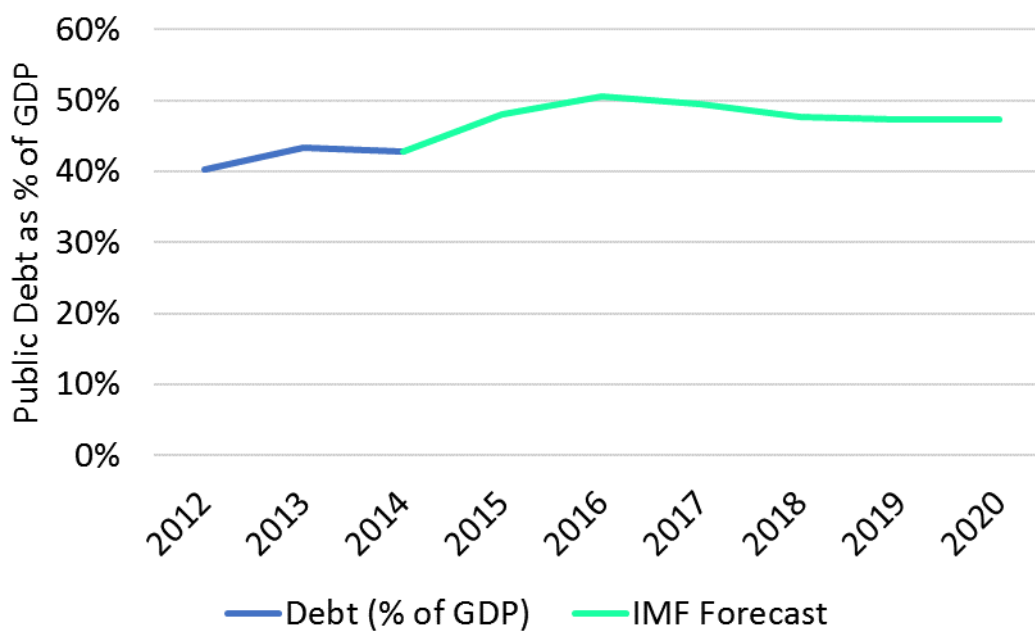

Source: IMF Country Report 2016.

However, Lesotho is at moderate risk of external debt distress. Negative shocks to exports or exchange rate depreciation pose a risk to debt sustainability. The projected, sustained reduction in SACU revenues, especially if of greater magnitude or duration than currently projected, could lead to unsustainable fiscal deficits without proper adjustment by Government, threatening debt sustainability further. Lesotho's debt sustainability is especially sensitive to risks associated with the LHWP—cost overruns, deterioration of financing conditions, and lower electricity demand than projected. Substantial cost

<sup>101</sup> IMF Country Report.



overruns could lead to public debt reaching 90 percent of GDP, bringing the country's prospects for growth into question. Low foreign demand for electricity would also threaten debt sustainability, even if there are no cost overruns associated with the project.

## Appendix C: Stakeholder Consultations

The Lesotho SREP IP is the result of a consultative process, led by the GoL and represented by the DoE to identify priority RE technologies for development in Lesotho. The consultations included a broad range of government agencies and representatives from the private sector, civil society, and international development partners. There were four consultations over the course of the IP’s preparation. A Scoping Mission, conducted in January was used to discuss the overall strategic approach of the IP with Government and energy sector stakeholders, commence data collection, understand Government’s strategic priorities and challenges facing the energy sector. Following the mission, an Options Study (OS) was prepared and shared with GoL, National Task Force, and MDBs for review (March 2017). The OS laid out the energy sector background, the assessment of the potential of various RE technologies in Lesotho as well as the main barriers to their development. Based on comments received on the OS, a draft IP was developed and distributed in April 2017 for comments and discussion with the main stakeholders. In May 2017, a Joint Mission was conducted to verify the correctness of the overall approach, identify priority projects and to gather additional materials needed for updating and finalizing the draft IP. During the Joint Mission, discussions were conducted with the DoE, private sector, NGOs, and donor agencies to ensure that the technology and models proposed in the draft IP were coherent and complementary with ongoing activities in Lesotho in terms of RE development and the energy access expansion program. The sub-sections below briefly describe the key findings and discussions from each consultation.

### C.1 Scoping Mission

The Consultant and World Bank teams participated in the Scoping Mission from January 9 to January 18, 2017 to kick start the preparation of the SREP. The main goal of the mission was to establish a strategic approach for the IP with Government and energy sector stakeholders so that it supports Government’s priorities and addresses challenges in the energy sector. Appendix Table C.1 lists the stakeholders met during the Scoping Mission.

**Appendix Table C.1: Stakeholders met during the Scoping Mission**

NAME	POSITION/ORGANIZATION	EMAIL
<b>GOVERNMENT ORGANIZATIONS</b>		
Seitlheko Jerry	DoE, Deputy Director	seitlhekojerry@gmail.com
Tlohelang Aumane	Ministry of Development Planning, Principal Secretary of Development Planning	mamotebang.lekoekoe@gov.ls
Tom Mpeta	Ministry of Finance, Principal Secretary	

Tsepiso Thabane; Malehloa Molato	Lesotho Bureau of Statistics, Head of Environment Statistics; Acting Director	tl_thabane@yahoo.com; emolato@gmail.com
Thuso Ntlama	LEWA, Manager-Economic Regulation	tntlama@lewa.org.ls
Tsibela Mochaba	Lesotho Highland Development Authority, Discipline Lead-Hydropower	tsibela.mochaba@lhwp2pmu.c o.ls
Nchemo Maile	Ministry of Agriculture, Principal Secretary	nchemo@yahooo.co.uk
Felix Malachamela	Rural water supply department, Principal Engineer	felixmalachamela@gmail.com
Leloko Mokhutsoane	REU, Project Manager	projectmanager@reu.gov.ls
Monica Moeko	LEC, Transmission and Distribution Manager	moeko@lec.co.ls

<b>PRIVATE SECTOR /NGOS</b>		
-----------------------------	--	--

Prof B.M. Taele	University of Lesotho Science & Technology Department	bm.taele@nul.ls
Stephen Walker	Africa Clean Energy, Manufacturing Director and Co-founder	Stephen.walker@ace.co.ls
Limpho Kokome	Mos-sun Clean Energy Technologies, Head of Design and Technical Team	limphokokome@gmail.com
Kopano Tsenoli	Appropriate Technology Services, Chief Engineer	ktsenoli@gmail.com
Matthew Orosz	1PowerAfrica, CEO and Managing Director	mso@mit.edu
Michael Hones	Solarlights, Founder	solarlights@web.de
Mantopi Martina de Porres Lebofa	Technologies for Economic Development, Director	mantopi@yahoo.com

<b>DEVELOPMENT PARTNERS</b>		
-----------------------------	--	--

Dan Croft	International Finance Corporation	dcroft@ifc.org
-----------	--------------------------------------	----------------

Limomane Peshoane	UNDP, Climate Change Policy Specialist	limomane.peshoane@undp.org
Sjaak De Boer	European Union Delegation, Operations- Water, Energy & Climate Change	jacobus.deboer@eeas.europa.eu
Farai Kanonda	AfDB	e.kanonda@afdb.org

Stakeholders identified key challenges that inhibit private investment and uptake of RE in Lesotho’s energy sector that the IP should aim to address. They include: lack of up-to-date baseline data and studies, limited access to financing, incomplete legal and regulatory framework, limited capacity for project implementation and maintenance from the institution to end-user level, high costs of delivering electricity and RE technologies to rural areas and cash flow problems among the rural population.

The Consultant Team met with the DoE, LHDA, the REU, and private sector RE vendors to develop a long-list of potential RE technologies for consideration in the SREP IP. It was agreed that the following RE technologies would be considered in the IP: utility-scale wind, solar, and waste-to-energy; microgrids; and distributed technologies such as clean cook stoves, SHSs, and SWHSs.

During the Mission, the DoE also agreed to organize a National Task Force that will be responsible for reviewing various drafts of the IP and facilitating its eventual approval. The National Task Force consists of staff from different government agencies, private sector and, NGOs.

## **C.2 Comments on the Options Study**

In March 2017, the Consultant Team submitted an OS to the GoL, National Task Force, and MDBs for review. The OS provided an overview of Lesotho’s economy and energy sector, barriers to RE development, and results of the technical, financial, and economic analysis of potential RE technologies considered for the country. The stakeholders provided valuable feedback on the sources used to estimate RE resource potential, assumptions used in the economic and financial analysis, and prioritization of RE technologies.

## **C.3 Joint Mission**

The Consultant Team, World Bank, AfDB, and International Finance Corporation participated in a Joint Mission from May 15 to May 18 to decide on priority investments for RE, determine implementation arrangements such as a monitoring and evaluation framework for the IP and potential financing arrangements for the investments. Consultations were also held with Government and various stakeholder groups to seek feedback on the draft IP. Appendix Table C.2 lists the stakeholders met during the Joint Mission.

**Appendix Table C.2: Stakeholders met During the Joint Mission**

Name	Position/Organization	Email
<b>MINISTRY OF ENERGY AND METEOROLOGY</b>		
Mathabo Mahahabisa	Principal Secretary MEM a.i	mmahahabisa@gmail.com
Majakathata Thakhisi	Principal Secretary MDP	thabam@rocketmail.com
Thabang Phuroe	Director Energy	tphuroe@yhao.com
Ramokuinihi Motai	Senior Economic Planner	rmotai@ymail.com
Mokhethi. J. Seithleko	Deputy Director	peo.re@energy.gov
Hlalele Hlalele	Programme Officer	hlalele@trc.org.ls
Khotso Moleleki	Director Public Debt	kmoleleki90@gmail.com
Lekhoa Fokothi	Principal Forestry Officer	lfokothi@yahoo.com
Lengeta Mabea	Principal Energy Officer	mabeald@yahoo.com
Mamashea Motabotabo	Senior Environment Officer	motabotabo@gmail.com
Nthabeleng Moorosi	Finance Assistant	nthabymoor@gmail.com
Rafael Ben	Energy Specialist	
Makhahliso Nokana	Senior Economic Planner	Mnokana@yahoo.com
Nthomeng Seephephe	Principal Energy Officer	nthomeny1@gmail.com
Matseleng Sepiriti	Technical Officer	maspyp@gmail.com
K. Jobo	Economic Planner	
Lehlohonolo Teba	Power Engineer	
<b>PRIVATE SECTOR /NGOS</b>		
Thabo Qhesi	CEO	Info.psf@gmail.com
Molibeli Tael	Ass. Professor	bm. tael
Thabang Motsoasele	Strategy & Dev Lead	thabang.motsoasele@gmail.com
Limpho Kokome	Technician	Info.moscet@gmail.com
Moruti Mphatsoe	Director	Mrimphatsoe87@gmail.com
Limakatso Mafelesi	Consultant	mafelesi@yahoo.co.uk
Khotso Mokitimi	Local Project Manager	Khotsi1981@gmail.com
Molepi Lelimo	Soultrain Technician	
Nthateng Mpofo	Engineer	nthateng@stginternational.org
Stephen Walker	GM	walker@ace.co.ls
Puleng Mosothoane	Soultrain project Coordinator	mosothoanepuleng@gmail.com
Mantopi Lebofa	TED	mantopi@yahoo.com
Motlatsi Mosaase	Prime Operations	motlatsimosaaase@gmail.com
Molepi Lelimo	Soultrain Technician	
Puleng Mosothoane	Soultrain project Coordinator	mosothoanepuleng@gmail.com

L. Mokhutsoane	Project Manager	
<b>DEVELOPMENT PARTNERS</b>		
Tom Jardine	EU Technical Assistance Facility	tom@energy-mrc.com
Deboer Jacobus	EU	jacobus.deboer@eeas.europa.eu
Hilary Mwale	USAID Deputy Director	hmwale@usaid.gov
Mabohlokoa Tau	Project Manager	Mabohlokoa.tau.undp.org

During the Mission, it was agreed that the World Bank would support the implementation of off-grid RE technologies such as microgrid technologies (solar, hydro, hybrid), Solar Rooftop, Stand-Alone Systems such as SHS. AfDB would support on-grid solar, wind, and small hydro investments. Private sector communicated important lessons learned regarding the implementation of off-grid RE technologies. They advised development partners to consider the use of micro financing through financial intermediation, which has been a successful mechanism for delivering distributed RE technologies such as clean cookstoves to the rural areas.

The Mission also agreed on several next steps to ensure the finalization of the IP and long-term sustainability of the proposed investments. It was reiterated to Government the importance of adopting several remaining pieces of the RE regulatory framework that was developed by LEWA and AfDB in 2015 and identifying implementing agencies for the proposed investments and M&E framework.

#### **C.4 Final Mission**

The Consultant Team, World Bank, and AfDB participated in a Joint Mission from September 27 to September 29 to: 1.) review and validate the investment priority areas with DoE following the comments received and discussions with stakeholders during the Joint Mission in May 2017; and 2.) discuss the measures that the GoL needs to implement to allow the timely submission of the SREP IP to the SREP Sub-Committee. Consultations were held with MEM; Ministry of Finance; and the Bureau of Statistics under the Ministry of Development Planning.

During the Mission, a third component was added to the IP after discussions with the DoE. It was decided that technical assistance should be provided to conduct detailed studies on the feasibility of small hydro generation. The Mission put forward suggestions of implementation agencies for the off-grid and on-grid projects for Government's consideration. For the off-grid project, the Mission suggested that the REU, which is mandated to implement rural electrification projects could serve as the implementing agency. For the on-grid project, the Mission suggested that a project implementation unit with the necessary expertise be created outside the LEC but preferably within the DoE to implement the project. A suggestion was also put forward that the DoE be responsible for implementing the technical assistance project as well as the overall monitoring and evaluation of the IP at the sector level. The Mission nevertheless reiterated to

Government the importance of 1.) providing confirmation on the entities that would be responsible for the implementation arrangements and monitoring evaluation related to the three proposed SREP activities and 2.) identify areas of weaknesses of the selected implementing entities that need capacity strengthening to ensure readiness for implementation, and monitoring and evaluation of the implementation of the SREP IP.

The Mission agreed to finalize the IP by October, 06 2017, which would be sent to SREP independent evaluators and also allow sufficient time for the GoL to endorse the IP by the end of October for submission to the SREP Sub-Committee in November 2017.

## Appendix D: Co-Benefits

Section 7.3 highlighted some of the environmental, social and gender co-benefits likely to result from Lesotho’s SREP IP. This section focuses specifically on the co-benefits tracked under SREP’s Revised Results Framework (as of June 1, 2012). Appendix Table D.1 lists the co-benefits considered under SREP’s Revised Results Framework, and describes how those co-benefits will be achieved in Lesotho.

**Appendix Table D.1: Co-Benefits Associated with SREP Impacts and Outcomes**

SREP Transformative Impact		
Results	Co-benefits	Description
<b>Support low carbon development pathways by increasing energy security.</b>	Avoided GHG emissions	<ul style="list-style-type: none"> <li>All of the technologies in Lesotho’s SREP IP could result in reduction of GHG emissions in line with global and national efforts to fight climate change.</li> <li>Each kWh generated domestically from the 20 MW solar plant will potentially offset a kWh of imported energy from South Africa—an offset of approximately 0.99 kg CO<sub>2</sub> per kWh<sup>102</sup>.</li> <li>Each household that can reduce the use of traditional cookstoves from improved access to energy (electricity or ICS) through the SREP IP could have an offset of 1-3 t CO<sub>2</sub> per stove<sup>103</sup> replaced</li> </ul>
	Employment opportunities	<ul style="list-style-type: none"> <li>The 20 MW solar PV plant and the microgrid projects both have the potential to create short term construction jobs.</li> <li>All technologies supported will allow for opportunities of long-term jobs in maintenance or retail sales (i.e. business centres).</li> <li>Access to energy will provide job opportunities for marginalized groups in rural areas and empowerment of women by reducing need to collect biomass.</li> </ul>
SREP Programme Outcomes		
Results	Co-benefits	Description
<b>Increased supply of RE New and additional resources for</b>	Increased reliability	<ul style="list-style-type: none"> <li>All of the technologies in Lesotho’s SREP IP will results in increased domestic capacity.</li> <li>Rural households will have improved access to modern energy services such as electricity and ICS</li> </ul>

<sup>102</sup> In ESKKOM’s *Integrated Report 2016* the CO<sub>2</sub> output for the previous year was

<sup>103</sup> Stockholm Environment Institute. “Assessing the Climate Impacts of Cookstove Projects: Issues in Emission Accounting.” Policy Brief. 2013. [Link](#).



**renewable energy  
projects/programmes**

(that use solar, pellets, paraffin, etc.), and be less dependent on increasingly scarce domestic biomass.

Reduced  
costs of RE

- Bids for the 20 MW tender were already competitive with imports from South Africa
- Demonstration of the first commercial project will attract investors in wind and hydro, where the cost might not currently be competitive, but will fall over time

## Appendix E: Comments from the Independent Technical Reviewer

Appendix Table E.1 below presents the recommendations received from the independent technical review of the IP and the Consultant Team’s response to each recommendation.

**Appendix Table E.1: SREP Project Preparation Grant Request (On-Grid RE Technologies)**

#	Recommendation	Response
1	It is recommended to identify institutional arrangements for projects preparation and implementation. Designated institution should be involved at early stages of preparation of the projects to gain knowledge and experience benefitting from the consultants to be hired.	<p>It is difficult to definitively specify the institutional arrangements now because capacity, as the reviewer notes, is limited and the mandate of some of the institutions is in flux. As we discuss more in the response to #3 below, a capacity building program supported by the EU has resulted in updated mandates for the sector institutions. This program is providing training to improve the DoE staff’s ability to manage projects and implement sector policy. One recommendation is to turn the REU, which is currently under the DoE, into a separate independent institution. Because this work is ongoing it was determined the best approach is to wait to project appraisal to identify the responsible institutions.</p> <p>Along with an assessment of capacity building needs (see below) both AfDB and the World Bank will evaluate the institution that is best suited to implement the project at the time of project appraisal. Language has been added in 7.1.1 and 7.2.1 to clearly identify the above point in the program description.</p>
2	It is recommended to envisage capacity building activities. It should be designed for all institutions involved in RE development, as well as for technical and engineering staff of private service providers or individuals. This will support the market creation and thus support transformative changes.	Agreed, capacity building will be needed to ensure that these programs are successful. An exact program was not specified because there are several ongoing initiatives, such as the EU’s DoE capacity building project and EU and UNDP off-grid programs, all aim to address some of the capacity gaps. Due to this ongoing work, it was determined that the capacity of the implementing institutions and other stakeholders will have to be evaluated at the

	<p>project appraisal stages. Both AfDB and the World Bank then build capacity building programs into each project to address any identified gaps.</p> <p>The Consultant Team found three priority areas where capacity support is needed. The proposed program does aim to address these three areas as follows:</p> <ul style="list-style-type: none"> <li>• RE Integration and load balancing. The main concern related to on-grid capacity is whether LEC is ready to manage the intermittent load of RE resources. Part of the RE integration study will evaluate LEC’s preparedness to manage new RE load and identify a possible capacity building program to prepare staff.</li> <li>• RE maintenance. Past attempts to install SHS and microgrids failed because the installed technologies were not maintained over time. The business models favored for both SHS and microgrids aim to address this problem by.</li> <li>• RE financing. As discussed in Section 7.2.1, part of the plan to establish a green financing facility notes that if necessary the World Bank will fund training on RE financial products and project evaluation. Another sentence has been added to make it clear the level of training will be further evaluated at the time of project appraisal.</li> </ul>
<p>3 It is recommended to attach a timeline agreed with the government regarding adoption of the legal-regulatory documents that will enhance enabling environment for RE investments.</p>	<p>It may be helpful to provide some explanation for why the legal-regulatory documents have yet to be implemented. Many of the components of the RE regulatory framework that was prepared for LEWA in 2015 have yet to be adopted for a couple reasons. First, changes in government and the political climate in recent years have slowed the law setting process. Elections in mid-2017 are believed to have created a friendlier political climate for adopting the outstanding RE framework pieces.</p> <p>Second, historically there has been confusion over the responsibilities of the various sector stakeholders, with both overlapping and missing</p>

		<p>responsibilities. This has made implementing the RE procurement schemes proposed in the RE framework challenging. The ongoing capacity building program being funded by the EU has proposed individual mandates for each institution (LEC, DoE, REU, and LEWA) that removes the ambiguity on sector responsibilities. Now that the above issues have been resolved, Ministry of Energy has committed to adopt the framework pieces needed to run the tender processes described in the IP. The Government plans to enact a new Energy Law in 2018 that will cover institutional mandates and tender processes. We have added some language in the policy overview section to explain that this is planned for 2018.</p>
4	<p>Examine the situation with the previous off-grid installations to identify the reasons of failure and minimize the potential risks by planning respective actions and measures.</p>	<p>The main problems with past attempts to install SHS and microgrids has been a lack of maintenance following installation. There was no market for technicians to upkeep the technology once it was installed in rural areas.</p> <p>The WB project design will aim to address the problem by selecting the business models that ensure maintenance of technology after it has been installed. The project design will draw on practices from other countries in Africa where there are examples of successfully building maintenance it into the business model.</p>
5	<p>Clarify LCOE for solar, hydro and wind.</p>	<p>The lower LCOEs for solar are driven by the lower CAPEX cost and extremely high capacity factors for solar. The CAPEX presented in Table 5.1 show that costs for wind is 50 percent and for SHPP is 115-160% higher than solar CAPEX. The resource potential for solar in Lesotho is also excellent.</p>
6	<p>Clarify FiT approach selection as a policy and the ongoing tender for solar PV IPP. What method is used for 70 MW solar PV plant.</p>	<p>For the reasons discussed in #3 above the FiT policy has not yet been adopted. The draft policy is for solar PV and wind projects 30 kW and less than 50 MW and small hydro projects less than 10 MW. The draft RE framework also includes a PPA template that will be used to establish the agreement between LEC and the RE operators. Due to the delay in establishing the RE framework the DoE decided to initiate its own 20</p>

		<p>MW tender to test the market. The tender process was used to both see what market potential existed and what the private sector would willing to charge.</p> <p>The 70 MW FOCAC project mentioned in the IP was discussed in initial meeting with the Consultant Team held in January 2017. Due to uncertainty about the future of this project the DoE has decided to remove it from the IP.</p>
7	<p>It is recommended to consider replacement of the feasibility studies for two hydro power plants with the site specific studies for solar or other necessary activities for enabling environment. First of all, the droughts, water stress, agriculture issues are potential climate change impacts for Lesotho, and construction of hydro power plant may have negative impact on environment. Development of HPP requires careful consideration of these issues. Second, the cost of HPP construction is more expensive as shown in the IP. Third, it is not clear if the envisaged hydro power plants are small or large. If they are more than 10 MW, the SREP normally does not finance it. And finally, to have scale effect it is better to focus finance and efforts on one or two technologies.</p>	<p>Agreed, the first two points on the disadvantages of hydro due to both environmental and cost concerns are well stated. It is true that both solar and wind were identified as having greater resource potential and a lower cost than small HPPs. The GoL, however, finds that the potential advantage of HPPs being more reliable to meet baseload demand outweighs its disadvantages. To achieve its goal to meet baseload power with domestic resources, the GoL made it a priority to include support for hydro in the IP.</p> <p>On the third point, the size of the HPPs sites to be studied was left vague intentionally. The Consultant Team had received feedback from CIF that while financing for HPP investment is limited to 10 MW, there is no set cap on the size of HPPs to be studied. The intention is to conduct studies on sites that around 10 MW shown to have the best potential identified in the ongoing RE mapping exercise. However, it was desired that size of the HPPs to be studies allow for some flexibility in the case that sites slightly more than 10 MW are shown to have high potential.</p> <p>We have added in the following footnote in the program description to explain this desire:</p> <p style="padding-left: 40px;">The intention is to conduct studies on sites that are within the range of small HPPs used in this IP (less than 10), but should sites with slightly more than 10 MW potential be identified as being among the best then it is desired to have flexibility to study these sites as well.</p>

8	Clarify if the added generation of electricity will increase access through the connection of new households to the grid or it will replace the electricity import.	<p>The additional grid-connected capacity supported through the on-grid component mostly aims to replace electricity imports, though it will also indirectly support new connection of customers within the LEC service area.</p> <p>The off-grid RE component is envisioned to be most impactful in increasing electricity access in the rural areas where access is currently lowest.</p>
9	It is recommended to introduce gender disaggregated monitoring indicators where applicable.	Thank you, we agree with this recommendation. We have disaggregated the “Increased access to modern energy services” target of 75,000 such that it is now 32,500 men; 32,500 women; and 500 SMES/community services. The target is derived from our estimate of the number microgrids and SHS that can be installed with the proposed financing. This disaggregation is like what was done in the Nicaragua SREP IP.
10	It is recommended also to include as an indicator the total volume of increased investments in RE to track the leverage and transformative impact.	We have added the following indicator: Volume of private sector finance in RE. The target is set at US\$ 34.4 million, or the amount of private finance in the financing plan.

## Appendix F: Overview of the Concept of LCOE

The LCOE “levelizes” or amortizes the total costs of a power plant over its lifetime. It is calculated as the discounted sum of expenditures divided by the discounted electricity generation over the asset’s lifetime. This is given as the formula below:

$$\frac{\sum_{t=1}^n \frac{I_t + M_t + F_t}{(1+r)^t}}{\sum_{t=1}^n \frac{E_t}{(1+r)^t}}$$

Where

- *t* is the reference year,
- $I_t$  is the investment expenditure in year *t*,
- $M_t$  is the operating expenditure in year *t*,
- $F_t$  is the fuel expenditure in year *t*,
- $E_t$  is the electricity generated in year *t*,
- *r* is the discount rate, and
- *n* is the life of the plant<sup>104</sup>.

The LCOE of each technology can then be ordered and summed to create a supply curve. A supply curve displays the cheapest generation on the lower left and the most expensive generation in the upper right. A threshold, such as the average cost of imports or cost of fossil generation, can be used to compare which technologies may be more competitive than current alternatives.

The main limitation of the LCOE model is that because it is simple, it ignores other important considerations. LCOE models also do not consider system costs, such as transmission upgrades need to accommodate intermittent RE<sup>105</sup>. Intermittency presents another problem: although the levelized cost over a lifetime may be cheaper for a wind turbine, market prices may be lower when it is operating. Conversely, a fossil fuel plant that has a higher levelized cost can be dispatched anytime the market price exceeds their marginal cost of generation<sup>106</sup>. Data can also be subjective: each parameter relies on assumptions. For example, LCOE calculations are sensitive to interest rates, which are usually held static. Interest rates are rarely stable over the asset life of a power plant. Therefore, care must be taken when evaluating different technologies using LCOE. It is a useful comparative tool but should not be used in isolation.

---

<sup>104</sup> Office of Indian Energy, U.S. Department of Energy, “Levelized Cost of Energy,” 2015. <https://energy.gov/sites/prod/files/2015/08/f25/LCOE.pdf>

<sup>105</sup> Alex Gilbert, “9 Reasons Why LCOE Can Misperceive,” 2016. <https://www.sparklibrary.com/9-reasons-why-lcoe-can-misperceive/>

<sup>106</sup> Paul L. Joskow, “Comparing the Costs of Intermittent and Dispatchable Electricity Generating Technologies,” 2011.

## Appendix G: Preparation Grant and MDB Payment Requests

Appendix Table G.1: SREP Project Preparation Grant Request (On-Grid RE Technologies)

SREP INVESTMENT PROGRAM			
Project Preparation Grant Request			
1. Country/Region:	Lesotho/Sub-Saharan Africa	2. CIF Project ID#:	(Trustee will assign ID)
3. Project Title:	On-grid RE technologies		
4. Tentative SREP Funding Request (in US\$ million total) for Project <sup>a</sup> at the time of Investment Plan submission (concept stage):	Grant: • US\$ 0.6 million	Loan: • US\$ 5 million	
5. Preparation Grant Request (in US\$):	US\$ 0.6 million	MDB: AfDB	
6. National Project Focal Point:	Mokhethi Seithleko, Deputy Director, DoE		
7. National Implementing Agency (project/program):	Ministry of Energy and Meteorology		
8. MDB SREP Focal Point and Project/Program Task Team Leader (TTL):	Focal point: Leandro Azevedo CIF Private Sector Specialist	TM: Farai Kanonda Chief Energy Investment	
<b>Description of activities covered by the preparation grant:</b>			
The grant will cover activities related to the preparation of a <b>renewable energy integration study</b> to identify necessary investments to the grid to absorb intermittent load from RE sources such as wind and solar.			
9. Outputs: Policy Framework			
Deliverable		Timeline	
Renewable energy grid integration study		March 2018	
10. Budget (indicative):			
Expenditures <sup>b</sup>		Amount (US\$ '000') – estimates	
Consultants/technical assistance		70	
Equipment		0	
Workshops/seminars/trainings		10	
Travel/transportation		22	
Others (admin costs/operational costs)		5	
Contingencies (max. 10%)		13	
<b>Total cost</b>		<b>120</b>	
Other contributions:			



11. <b>Timeframe<sup>c</sup></b> (tentative): -
12. <b>Other partners involved in project design and implementation<sup>d</sup></b> : DoE
13. <b>If applicable, explanation for why the grant is MDB executed:</b> N/A
14. <b>Implementation Arrangements</b> (including procurement of goods and services): AfDB will administer the total amount of the SREP grant. AfDB will hire a consulting firm and individuals in accordance with its Rules and Procedures for the Use of Consultants (May 2008 Edition , Revised July 2012). The Consultants will be engaged through the fixed-budget selection method. The technical assistance proceeds will be disbursed in line with AfDB's Disbursement Handbook. Consultancy services will be announced in the United Nations Development Business Journal.

a. Including the preparation grant request.

b. These expenditure categories may be adjusted during project preparation according to emerging needs.

c. In some cases, activities will not require approval of the MDB Board.

d. Other local, national, and international partners expected to be involved in project design and implementation.

**Appendix Table G.2: MDB Request for Payment for Project Implementation Services**

<b>SCALING-UP RENEWABLE ENERGY PROGRAM IN LOW INCOME COUNTRIES</b>		
<b>MDB Request for Payment of Implementation Services Costs</b>		
<b>1. Country/Region:</b>	Lesotho / Sub-Saharan Africa	<b>2. CIF Project ID#:</b> (Trustee will assign ID)
<b>3. Project Title:</b>	On-Grid RE Technologies	
<b>4. Request for project funding (US\$ mill.):</b>	<i>At time of country program submission (tentative):</i> US\$ 5.6 million	<i>At time of project approval (tentative):</i>
<b>5. Estimated costs for MDB project implementation services (US\$ mill.):</b>	<i>Initial estimate - at time of Country program submission:</i> US\$ 420,000	MDB: AfDB
	<i>Final estimate - at time of project approval:</i>	Date: February 2018
<b>6. Request for payment of MDB Implementation Services Costs</b>	<input checked="" type="checkbox"/> First tranche: US\$ 210,000 <input type="checkbox"/> Second tranche:	Subject to the availability of investment financing for the project
<b>7. Project/program financing category:</b>	a - Investment financing - additional to ongoing MDB project <input type="checkbox"/>	<input type="checkbox"/>
	b- Investment financing - blended with proposed MDB project <input type="checkbox"/>	<input checked="" type="checkbox"/>
	c - Investment financing - stand-alone <input type="checkbox"/>	<input type="checkbox"/>
	d - Capacity building - stand-alone <input type="checkbox"/>	<input type="checkbox"/>
<b>8.Expected project duration</b>	3 years	
<b>9. Explanation of final estimate of MDB costs for implementation services:</b>	N/A	
<b>10. Justification for proposed stand-alone financing in cases of above 6 c or d: N/A</b>		

**Appendix Table G.3: SREP Project Preparation Grant Request (Distributed RE solutions)**

<b>SREP INVESTMENT PROGRAM</b>			
<b>Project Preparation Grant Request</b>			
<b>2. Country/Region:</b>	Lesotho/Sub-Saharan Africa	<b>2. CIF Project ID#:</b>	
<b>3. Project Title:</b>	Distributed RE Solutions		
<b>4. Tentative SREP Funding Request (in US\$ million total) for Project<sup>a</sup> at the time of Investment Plan submission (concept stage):</b>	<b>Grant:</b> US\$4.9 million	<b>Loan:</b> US\$ 8 million	
<b>5. Preparation Grant Request (in US\$):</b>	US\$ 0.9 million	World Bank	
<b>6. National Project Focal Point:</b>	Mokhethi Seitlheko, Deputy Director, DoE		
<b>7. National Implementing Agency (project/program):</b>	Ministry of Energy and Meteorology		
<b>8. MDB SREP Focal Point and Project/Program Task Team Leader (TTL):</b>	Focal point: Monyl Toga Energy Specialist	TTL: Vonjy Miarintsoa Rakotondramanana Senior Energy Specialist	
<b>Description of activities covered by the preparation grant:</b>			
The grant will cover activities related to the preparation of pre-feasibility studies for small hydropower sites identified as having high potential in the national resource mapping study.			
<b>9. Outputs: Policy Framework</b>			
<b>Deliverable</b>		<b>Timeline</b>	
Pre-feasibility study for (at least one) of SHPP site		2019	
<b>10. Budget (indicative):</b>			
<b>Expenditures<sup>b</sup></b>		<b>Amount (US\$ Million) – estimates</b>	
Consultants/technical assistance		US\$0.9 million	
Equipment			
Workshops/seminars/trainings			
Travel/transportation			
Others (admin costs/operational costs)			
Contingencies (max. 10%)			
<b>Total cost</b>		US\$0.9 million	
Other contributions:			
<b>11. Timeframe<sup>c</sup> (tentative): -</b>			
<b>12. Other partners involved in project design and implementation<sup>d</sup>:</b>			

**13. If applicable, explanation for why the grant is MDB executed:** Given the lack of national experience preparing site specific studies, and the World Bank's ongoing experience with medium and large hydropower in Lesotho, a Bank-executed grant is requested.

**14. Implementation Arrangements** (including procurement of goods and services):

The procurement will be conducted by the World Bank following its guidelines.

- a. Including the preparation grant request.
  - b. These expenditure categories may be adjusted during project preparation according to emerging needs.
  - c. In some cases, activities will not require approval of the MDB Board.
  - d. Other local, national, and international partners expected to be involved in project design and implementation.
-

**Appendix Table G.4: MDB Request for Payment for Project Implementation Services**

SCALING-UP RENEWABLE ENERGY PROGRAM IN LOW INCOME COUNTRIES			
MDB Request for Payment of Implementation Services Costs			
<b>1. Country/Region:</b>	Lesotho / Sub-Saharan Africa	<b>2. CIF Project ID#:</b>	(Trustee will assign ID)
<b>3. Project Title:</b>	Distributed RE Solutions		
<b>4. Request for project funding (US\$ mill.):</b>	<i>At time of country program submission (tentative):</i> US\$ 12.9 million	<i>At time of project approval:</i>	
<b>5. Estimated costs for MDB project implementation services (US\$ mill.):</b>	<i>Initial estimate - at time of Country program submission:</i> US\$ 420,000	MDB: World Bank	
	<i>Final estimate - at time of project approval:</i>	Date: June 2018	
<b>6. Request for payment of MDB Implementation Services Costs</b>	<input checked="" type="checkbox"/> First tranche: US\$ 210,000  <input type="checkbox"/> Second tranche:	Subject to the availability of investment financing for the project	
<b>7. Project/program financing category:</b>	a - Investment financing - additional to ongoing MDB project <input type="checkbox"/>	<input type="checkbox"/>	
	b- Investment financing - blended with proposed MDB project <input type="checkbox"/>	<input checked="" type="checkbox"/>	
	c - Investment financing - stand-alone <input type="checkbox"/>	<input type="checkbox"/>	
	d - Capacity building - stand-alone <input type="checkbox"/>	<input type="checkbox"/>	
<b>8. Expected project duration</b>	5 years		
<b>9. Explanation of final estimate of MDB costs for implementation services:</b>	N/A		
<b>10. Justification for proposed stand-alone financing in cases of above 6 c or d:</b>			

# Independent Technical Review of the Investment Plan for Lesotho

1. Title of the investment plan: **Investment Plan for Lesotho**
2. Program under the SCF: **Program for Scaling up Renewable Energy in Low Income Countries (SREP)**
3. Name of the reviewer: **Tamara Babayan**

## Introduction

The o c k " q d l g e v x g " q h ' y k u ' s w c r k \{ " t g x l g y " k u ' v q " u w r r q t v ' y g ' f g x g n r o g p v ' q h ' y g " N g u q y q a " U T G R " Investment Plan and to facilitate the process of endorsement. The review was done without visiting the country and participating in the meetings with stakeholders. This may have an impact on some interpretations. The final report of the review will reflect all the clarifications and details received. The review was done based on the draft provided on October 30, 2017. All abbreviations used in this report are the same as provided in the IP. The review report is structured according to the requirements of the TOR for Independent Review. The Section 5, provides information on compliance with the general criteria and the Section 6. presents whether the investment plan meets the SREP specific criteria.

## Background

According to the IP the energy sector in Lesotho faces challenges which include:

- i) low access to modern and clean forms of energy;
- ii) reliance on imported electricity and fuels (an energy security problem);
- iii) dwindling forest reserves.

V j g " I q x g t p o g p v ' q h ' N g u q y q " t g e q i p k g u " v j c v ' y g u g " e j c m g p i g u " c t g " c " d c t t k g t " v q " y g " e q w p t \{ a " development and has set targets to expand electricity access to 90 percent and increase the use of renewable energy sources by 200MW by 2020. The Government of Lesotho (GoL) is also committed to promoting the safe use of biofuels, reversing environmental degradation, and increasing the use of renewable energy sources to increase energy security.

The proposed SREP IP aims to overcome the mentioned challenges through the following activities supported by SREP under the IP respective components:

- a) Component 1: On-grid RE technologies.
  - a. Investment in utility-scale solar PV plant
  - b. Development of RE integration study
  - c. Solar PV site specific studies
- b) Component 2: Off-grid RE technologies
  - a. Investment in microgrids
  - b. Investment in SHS or other stand-alone systems
  - c. TA for preparation of microgrid tenders

- c) Component 3: SHPP Technical Assistance
  - a. Preparation of two feasibility studies for hydropower plants

The exact financing modalities will be determined at the time of appraisal, but it is expected that:

US\$5.6 million of SREP funding, in the form of grants or concessional loans, would be used to leverage US\$11.5 million in grants and private concessional loans (or a PRG) from AfDB, \$7.5 million in equity contributed from the developers of a 20 MW solar PV project, and \$6.9 million in additional financing from either a private lender or other DFI.

US\$12.9 million of SREP funding would be used to leverage US\$ 10 million in financing from the World Bank, and US\$20 million in investment from other private sector investors in microgrids and other distributed RE technologies.

US\$1.5 million in SREP funding would be used towards the preparation of two hydropower pre-feasibility studies.

The GoL will contribute by facilitating fiscal incentives for services associated with the financing plan. These incentives will possibly include: waiving corporate profit tax for the first 10 years of operation and excluding RE technology sales from VAT.

## Part I: General criteria

Vj g"Nguy qai"fxguo gpv"Rcp"ku"ceqo r tgj gpukg"fqewo gpv"y kj "ko r tguukg"lphqto cvkg"cpf " analytical details about the country, energy sector, IP preparation processes, prioritization of RE vgej pqmji lgu." OFD" cpf " f gxgnr o gpv" r ctvgtuø tgrxcpv" ce vkkkgu." r tkcvg" ugevqt" cpf " PI Q" participation, etc. It is consistent with the general criteria and SREP operational criteria. Comments and concerns aim to further strengthen the GoL commitment to promote RE in Lesotho. Below the results of the review is presented according to the general and specific criteria stipulated for the SREP.

### 1.1. Compliance with the principles, objectives and criteria of the relevant program as specified in the design documents and programming modalities

The Investment Plan generally complies with principles, objectives and criteria of the SREP<sup>1</sup>. It was prepared through broad participatory process, it takes into account the strategies and long-term policies of the GoL, it envisages private sector participation, seeks wider economic, social and environmental co-benefits, etc.

### 1.2. Does the IP take into account the country capacity to implement the plan?

The IP is quite ambitious both for on-grid and off-grid technologies. At the same time, the IP mentions a lack of implementation capacity in the country or it does not reflect all institutions involved in the project preparation and implementation. During the IP preparation the GoL has not identified institution that will be responsible for implementation of the proposed projects. The decision was postponed to the project preparation stage. This creates risks for smooth commencement of the relevant activities envisaged in the IP. Proposed MDB administration (implementation) and engagement of consultants reduces the implementation risk but at the same

---

<sup>1</sup> The aim of the SREP is to pilot and demonstrate, as a response to the challenges of climate change, the economic, social and environmental viability of low carbon development pathways in the energy sector by creating new economic opportunities and increasing energy access through the use of renewable energy.

time it hinders promotion of country institutions growth and enhancement of the institutional capacity, which is critical for sustainability of the efforts under the IP and overall transformational change success.

### 1.3. Has the IP been developed based on the sound technical assessments

The Investment Plan was developed based on the solid technical, analytical studies and the most recent data available in the country. It provides detailed analytical information about all aspects of the IP. It introduces the country context and macroeconomic indicators, energy sector situation and challenges, demand and supply study, f Hgtgpvtgpgy cdr g"gpgti {"gej pqrqi lguø'equ'cpcn{uku." projections, etc. It contains information about all RE technologies, not only on those included in the proposed projects. Detailed review and prioritization of all technologies based on agreed evaluation criteria allows assess the reasons of selecting priority technologies and activities under the SREP IP. During preparation of IP the information, surveys and studies conducted by MDBs and development partners were taken into account.

### 1.4. Does the IP demonstrate how it will initiate transformative impact?

The IP envisages engagement of private investors, IPPs, vendors and service providers for on-grid and off-grid RE generation. It also involves local banks for financing of RE investments. These are the key preconditions to initiate transformational changes in the country. Another precondition is creation of institutional mechanisms to support sustainability and replication of the efforts and activities. Here the IP does not provide adequate information to show how the GoL will ensure results of the proposed projects and continue the development of the sector, particularly it is not clear what institutions will be responsible for tenders for on-grid and off-grid technologies. The lessons from the previous solar home system installations shows that as a result of the lack of capacity the installed systems stopped their operation. Extensive capacity building is important not only to ensure quality of the tender processes for different components of the IP, but also to develop vj g"o ctngv'd {"gpj cpekpj "r qvkvkn' uwr r ngtuø' ecr cekv{0' The other critical component of the transformational change is the legal regulatory framework that enables investments in the RE sector. The IP presents in details the current legislation regulating the sector. It has serious lacks, including the absence of the Law on Energy. Nevertheless, the IP describes also activities initiated by MDBs and donor institutions toward improvement of the energy sector legislation.

### 1.5. Does the IP provide for prioritization of investments, stakeholder consultation and engagement, adequate capturing and dissemination of lessons learned, and monitoring and evaluation and links to the results framework?

The Investment Plan was prepared through the extensive participatory process in Lesotho, including meetings with participation of the MDB representatives. An assessment of technical potential for various RE technologies that can be used in Lesotho was carried out to support the preparation of the SREP IP. Each of the potential RE resources were then evaluated against national and SREP criteria, and prioritized accordingly. The criteria and prioritisation ranking is included in the IP. The national priority criteria preferred technologies that would result in job creation, improved energy security, and increased private sector investment. The IP reflects previous experience in Lesotho with regard to the RE development, including pilot projects implemented by different organizations during the past years. The IP also mentions that the MDBs will take into account the experience and lessons learned in other countries during the preparation of the projects. An M&E system will be established by the GoL, in cooperation with MDBs and other donor partners to track and report the Rtqi tco øu progress and results. The monitoring and



evaluation framework will be coordinated by the Renewable Energy Division of the Department of Energy. The gender disaggregated indicators should be introduced.

#### 1.6. Does the IP adequately address social and environmental issues, including gender?

The IP identifies the main social and environmental risks and benefits for all planned technologies. The IP prioritizes technologies that will prevent the deforestation of the country, reduce local pollution and health issues due to the replacement of the paraffin and kerosene with clean energy. Gender issue is also reflected in the IP. Vj g"öi gpf gtö"y cu"qpg"qh"vj g"etkgtk"lqt"tcpnki "vj g" technologies to include into the IP. Technologies that directly promote gender inclusiveness and increase opportunities for women were ranked higher.

#### 1.7. Does the IP support new investments or funding additional to on-going/planned MDB investments?

The IP presents the on-going projects in RE development financed by private sector, NGOs and development partners. All activities are described in the IP. The main partners, EU, AfDB, UNDP/GEF and Government of Italy provide about \$58.1mln financing for TA for enabling environment and investments. The China-Africa Cooperation funded project will build a 70 MW solar park. Regarding the latest there is no information about possible intersection of the solar PV development approaches.

#### 1.8. Does the IP take into account institutional arrangements and coordination?

The IP presents the institutional structure of energy sector. There is serious legislative gap for regulation of responsibilities and relationship between energy sector institutions. The overlapping institutional mandates is one of the barriers for private investors. The IP clearly mentions that the overall coordination of the SREP IP activities will be coordinated by the Department of Energy of the Ministry of Energy and Meteorology. However, there is no designated institution for implementation of the preparation and implementation of the SREP projects.

#### 1.9. Does the IP promote poverty reduction?

One of the key objective of the IP is the increased access to modern clean energy services in urban and rural areas. It will help to reduce energy expenses of the families given the energy poverty situation in the country, as well as to address some issues related to the human poverty, such as health improvement due to the cleaner options for heating, lighting and cooking, opportunities for women and child to have more time for self-development. The extensive development of standalone RE systems will create new opportunities for business, as well as create sustainable jobs thus fighting unemployment and poverty.

#### 1.10. Does the IP consider cost effectiveness of investments?

The IP has a detailed analysis of the LCOE for all potential RE technologies applicable in Lesotho. All assumptions and methodologies are presented in the IP that helps to assess a viability of the selected technologies. Presented LCOE for solar PV, wind and hydro are different from those published by IRENA for 2016. Although it is clarified that the cost of technology adapted to Lesotho, and it includes cost of connection and necessary investments in the grid infrastructure, however the relative costs are also different. In the assumptions the capital cost of the solar PV is 2-4 times less than the costs of wind and hydro. Additional clarification may be useful to understand the reasons for costs difference. The cost analysis confirms the selection of solar PV

as a priority project under the IP, however it raises question regarding the need for feasibility study for hydropower plants given the much higher capital cost needed for hydro power plant option.

## Part II: compliance with the investment criteria of the SREP

### 2.1. Catalyze increased investments in renewable energy in total investment

The investment plan envisages engagement of private developer for large scale solar PV project, with possible private lending or PRG from AfDB and equity funding of the private IPP. According to the IP the GoL will contribute by facilitating fiscal incentives for services associated with the financing plan. These incentives will possibly include: waiving corporate profit tax for the first 10 years of operation and excluding RE technology sales from VAT. Although this shows the willingness of government to support RE development, however VAT exemption has negligible impact if there is no VAT exemption on imported PV equipment. It may create administrative barriers for investors. The off-grid component is also designed to have a catalyzing effect through engagement of local banks and vendors, demonstration of benefits and viability of options, creation of market of vendors and service providers.

### 2.2. Enabling environment

Vj g'lp'xguo gpv't rcp't t'gugp'u'yj g'eqwpt {a'long-term commitment to promoting renewable energy as part of its energy sector strategies and energy access goals. It envisaged some activities to enhance the enabling environment for RE investments. At the same time the IP presents relevant on-going and planned activities of other donors aimed to remove the barriers and increase attractiveness for private investments. There is confusing information in the IP regarding the preference of the FIT approach for the GoL and the current tender for solar PV plant development. Additional clarification will be useful here.

### 2.3. Increase energy access

Nguqj qa'IR'cklo u"vq"l'petgcug"yj g"ceegu"vq"o qf gtp"engcp"gpgti {"yj tqwi j "qp-grid and off-grid renewable energy technologies scale up. Particularly a 20 MW Solar PV park generation indirectly will support the additional connections. Microgrid and off grid technologies selected under the IP will help residents to replace paraffin, candles and wood by the clean energy options. Results framework provides access level indicators for electricity and modern energy options. It is not clear if the added electricity generation will replace the import or increase the connections given the GoL goals to reduce dependence on imported energy.

### 2.4. Implementation capacity

The implementation arrangements are not specified in the IP. The GoL will identify implementing agency (es) later at the project preparation stage. At the same time IP mentions about the lack of implementing capacity in the country. The preparation of the projects will be implemented by the MDBs. This reduces risk of implementation, but also does not give an opportunity to local institutions to enhance their capacity for implementation of further similar projects.

### 2.5. Improve the long-term economic viability of the renewable energy sector

The IP presents the results of economic viability analysis by comparing on-grid options to the cost of imported electricity and the off-grid options are compared to the cost of off-grid diesel generation. All selected on-grid technologies are viable, except the hydro. All selected off-grid technologies are viable except the SHS, however the latest is viable if compared to cost of paraffin, kerosene, candles. This analysis shows that these options will be even more viable and attractive

for private sector after implementation of the SREP projects due to the demonstration effect, enhanced skills, as well as due to the competitive market development.

## 2.6. Transformative impact

The investment plan demonstrates transformative impact by installation of the first utility-scale solar PV power plant, which will create interest and confidence of private sector investors to invest in RE technologies; by introduction of the business model for off-grid technologies and engagement of local banks in the process. However there is risk that the existing gaps of legal-regulatory framework, lack of implementation capacity and technical/professional capacity, the sustainability of the projects is questioned. It is also important to focus the efforts under the SREP to one or two technologies to have a scale effect.

## Part III. Recommendations

1. It is recommended to identify institutional arrangements for projects preparation and implementation. Designated institution should be involved at early stages of preparation of the projects to gain knowledge and experience benefitting from the consultants to be hired.
2. It is recommended to envisage capacity building activities. It should be designed for all institutions involved in RE development, as well as for technical and engineering staff of private service providers or individuals. This will support the market creation and thus support transformative changes.
3. It is recommended to attach a timeline agreed with the government regarding adoption of the legal-regulatory documents that will enhance enabling environment for RE investments.
4. Examine the situation with the previous off-grid installations to identify the reasons of failure and minimize the potential risks by planning respective actions and measures.
5. Clarify LCOE for solar, hydro and wind.
6. Clarify FIT approach selection as a policy and the on-going tender for solar PV IPP. What method is used for 70 MW solar PV plant.
7. It is recommended to consider replacement of the feasibility studies for two hydro power plants with the site-specific studies for solar or other necessary activities for enabling environment. First of all, the droughts, water stress, agriculture issues are potential climate change impacts for Lesotho, and construction of hydro power plant may have negative impact on environment. Development of HPP requires careful consideration of these issues. Second, the cost of HPP construction is more expensive as shown in the IP. Third, it is not clear if the envisaged hydro power plants are small or large. If they are more than 10 MW, the SREP normally does not finance it. And finally, to have scale effect it is better to focus finance and efforts on one or two technologies.
8. Clarify if the added generation of electricity will increase access through the connection of new households to the grid or it will replace the electricity import.
9. It is recommended to introduce gender disaggregated monitoring indicators where applicable.

10. It is recommended also to include as an indicator the total volume of increased investments in RE to track the leverage and transformative impact.